

E145

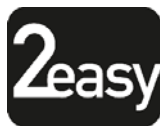
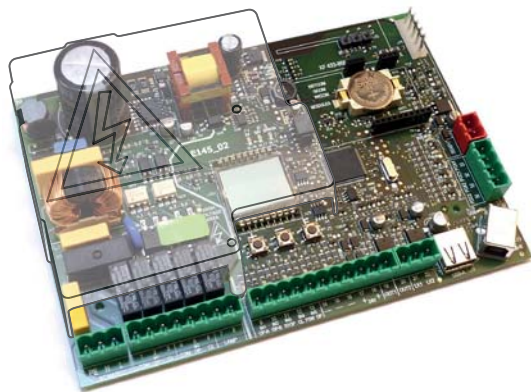

FAAC

CE DECLARATION OF CONFORMITY

The manufacturer

Company name: FAAC S.p.A. Soc. Unipersonale

Address: Via Calari, 10 - 40069 Zola Predosa BOLOGNA - ITALY

hereby declares that the following product:

Description: control board

Model: E145

conforms to the essential safety requirements of the following ECC directives:

Low Voltage Directive 2014/35/EU

Electromagnetic Compatibility Directive 2014/30/EU

Directive ROHS 2011/65/EU

Furthermore, the following harmonised standards have been applied:

EN 60335-1:2012 + A11:2014 - EN 61000-6-2:2005 - EN 61000-6-3:2007 + A1:2011

Additional note: this product underwent tests in a typical uniform configuration (all products manufactured by FAAC S.p.A.).

Bologna, January the 1st 2016

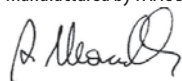
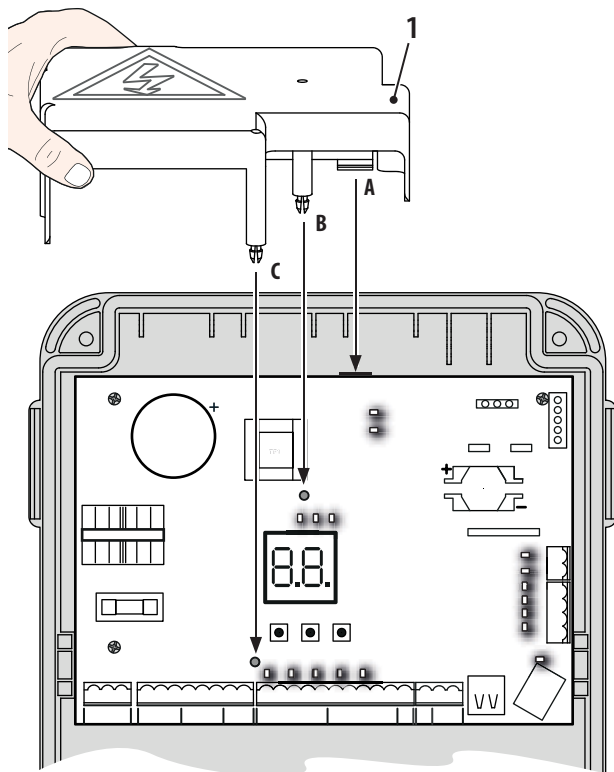
- Interrupt the electrical power supply before working on the control unit. The protection cover (1) needs to be installed before switching on the power supply.

WARNINGS FOR THE INSTALLER

GENERAL SAFETY OBLIGATIONS

1. **ATTENTION!** To ensure the safety of people, it is important that you read all the following instructions. Incorrect installation or incorrect use of the product could cause serious harm to people.
2. Carefully read the instructions before beginning to install the product.
3. Do not leave packing materials (plastic, polystyrene, etc.) within reach of children as such materials are potential sources of danger.
4. Store the instructions for future reference.
5. This product was designed and built strictly for the use indicated in this documentation. Any other use, not expressly indicated here, could compromise the good condition/operation of the product and/or be a source of danger.
6. FAAC S.p.A. declines all liability caused by improper use or use other than that for which the automated system was intended.
7. Do not install the equipment in an explosive atmosphere: the presence of inflammable gas or fumes is a serious danger to safety.
8. FAAC S.p.A. is not responsible for failure to observe Good Technique in the construction of the closing elements to be motorised, or for any deformation that may occur during use.
9. The installation must conform to Standards EN 12453 and EN 12445. For non-EU countries, to obtain an adequate level of safety, the Standards mentioned above must be observed, in addition to national legal regulations.
10. Before attempting any job on the system, cut out electrical power and disconnect the batteries if present.
11. The mains power supply of the automated system must be fitted with an all-pole switch with contact opening distance of 3mm or greater. Use of a 6A thermal breaker with all-pole circuit break is recommended.
12. Make sure that a differential switch with threshold of 0.03 A is fitted upstream of the system.
13. Make sure that the earthing system is perfectly constructed, and connect metal parts of the means of the closure to it.
14. The automated systems that feature a built-in anti-crushing safety device in any case require a functional check in accordance with the provisions of the Standards indicated at point 9.
15. The safety devices (EN 12978 standard) protect any danger areas against mechanical movement Risks, such as crushing, dragging, shearing, lifting.
16. Use of at least one indicator-light (e.g.: flashing lamp) is recommended for every system, as well as a warning sign adequately secured.
17. FAAC S.p.A. declines all liability as concerns safety and efficient operation of the automated system, if system components not produced by FAAC S.p.A. are used.
18. For maintenance, strictly use original parts by FAAC S.p.A.
19. Do not in any way modify the components of the automated system.
20. The installer shall provide the User with all information concerning manual operation of the system in case of an emergency.
21. Do not allow children or adults to stay near the product while it is operating.
22. Keep radio controls or other pulse generators away from children, to prevent the automated system from being activated involuntarily.
23. Transit is allowed only when the automation is fully open.
24. The User must not attempt any kind of repair or direct action whatever and contact qualified personnel only.
25. Anything not expressly specified in these instructions is not permitted.

MEANING OF THE SYMBOLS USED



Important for the safety of persons and for the good condition of the automated system.



Notes on the characteristics and operation of the product.

INDEX

CE DECLARATION OF CONFORMITY	2
WARNINGS FOR THE INSTALLER.....	3
1. TECHNICAL SPECIFICATIONS.....	5
2. PREPARING FOR INSTALLATION.....	6
3. BOARD LAYOUT.....	6
4. ELECTRICAL CONNECTIONS	8
4.1 J1 - Mains primary Power Supply.....	8
4.2 J2 - Motors and Flashing lamp	8
4.3 J3 - Low-voltage accessories - inputs/outputs	9
4.4 J12 - programmable outputs - electric locks.....	10
4.5 J12 -J6 - LIMIT SWITCH AND GATECODER.....	10
4.6 J10 - BUS-2EASY ACCESSORIES.....	11
BUS-2EASY photocells.....	11
Address assignment of BUS-2EASY photocells	12
Connection of BUS-2EASY photocells.....	12
BUS-2EASY encoder.....	13
Connection - Address assignment of BUS-2EASY Encoder.....	13
4.7 J5 - XF module RAPID CONNECTOR	14
4.8 J14 - Decoder/Minidec/RP RAPID CONNECTOR.....	14
4.9 M1A - MODULE RAPID CONNECTOR.....	14
4.10 traditional photocells.....	15
5. PROGRAMMING	18
5.1 Basic PROGRAMMING functions.....	19
5.2 Advanced PROGRAMMING functions.....	24
5.6 BUS-2EASY DEVICE INSTALLATION	30
5.6.1 BUS-2EASY DEVICE ENTRY.....	30
Checking the securing devices entered on the board.....	31
5.4 TIME LEARNING - SETUP.....	32
5.5 TESTING THE AUTOMATED SYSTEM.....	33
6. MEMORISING THE RADIO CODE.....	34
6.1 MEMORISING THE SLH/SLH LR RADIO CONTROLS	34
6.2 MEMORISING LC/RC RADIO CONTROLS (ONLY 433 MHz)	35
6.2.1 REMOTE MEMORISATION OF LC/RC RADIO CONTROLS	36
6.3 MEMORISING DS RADIO CONTROLS.....	36
6.4 DELETING THE RADIO CONTROLS.....	37
7. START-UP.....	38
7.1 CHECKING THE LEDs.....	38
8. SIGNALLING ERRORS AND ALARMS	39
8.1 ERRORS.....	39
8.2 ALARMS.....	40
9. TROUBLESHOOTING.....	41
10. MANAGING THE CONFIGURATION FILE – J8 USB	42
11. FUNCTION LOGICS	45

CONTROL BOARD E145

We thank you for having chosen one of our products. **FAAC** is certain that from it you will obtain all the performance you require. All our products are the result of years of experience in the field of automated systems.

1. TECHNICAL SPECIFICATIONS

PURPOSE: this electronic control board has been designed and built to control swing-leaf and/or sliding gates for vehicle and pedestrian access control.



Thanks to the innovative power **supply switching system**, the board is able to automatically adapt to different input voltages (from 90V~ to 260V~), maintaining constant the output value of accessories, without being affected by variations.

During programming you can choose between different function logics.

2 programming levels are available from the board (BASIC and ADVANCED), using buttons and LCD display.

This board also allows you the programming using PC or MAC, connected via USB-B.

Tab. Technical specifications

Mains primary power supply	With power supply switching from 90 V~ to 260 V~; 50/60Hz		
Power absorbed from mains	stand By = 4W	sleep < 2 W  *	MAX ~ 800 W
	 * FUNCTION THAT CAN BE ENABLED FROM A PC/MAC		
MAX load for motors	800 W		
Accessories power supply	24 V---		
MAX. accessories current	+24V MAX 500 mA	BUS 2easy MAX 500 mA	
	LOCK (FAAC) 12 V~ / 24 V---	LOCK (not FAAC) 24 V--- 500mA (3A peak)	
Operating ambient temperature	from -20°C to +55°C		
Power supply safety fuses	F1 = F10AH250V		
Work time	Self-learned through SETUP - (Max 4 min and 10 sec)		
Pause time	Programmable (from 0 to 9 min and 50 sec)		
Motor power	Programmable on 50 levels		
Connector inputs	Decoder/Minidec/RP, XF433/868 Module, USB-A, USB-B		
Terminal board inputs	Mains power supply from 90 to 260V ~, Inputs from IN1 to IN5, Limit switch, BUS 2easy		
Terminal board outputs	Flashing lamp, Motors, Electric lock (LOCK1 and LOCK2), OUT1 and OUT2 (programmable), Accessories power supply		

2. PREPARING FOR INSTALLATION

⚠ For safety reasons, it is important for people to carefully follow all the warnings and instructions contained in this manual. Incorrect installation or incorrect use of the product can cause serious harm to people. Before proceeding with product installation, carefully read the entire manual. Keep these instructions for further reference.

⚠ Always cut off the electrical power before carrying out any work on the control unit (connections, maintenance).

Always separate the power cables from the control and safety cables (button, receiver, BUS 2easy encoder, photocells, etc.). Avoid any electrical disturbance using separate sheathing or a shielded cable (with shield connected to the earth).

- Ensure that upstream of the system there is a suitable magnetothermic differential switch with omnipolar cut-off, as provided for in current safety regulations.
- Check for the presence of an adequate earthing system.

3. BOARD LAYOUT

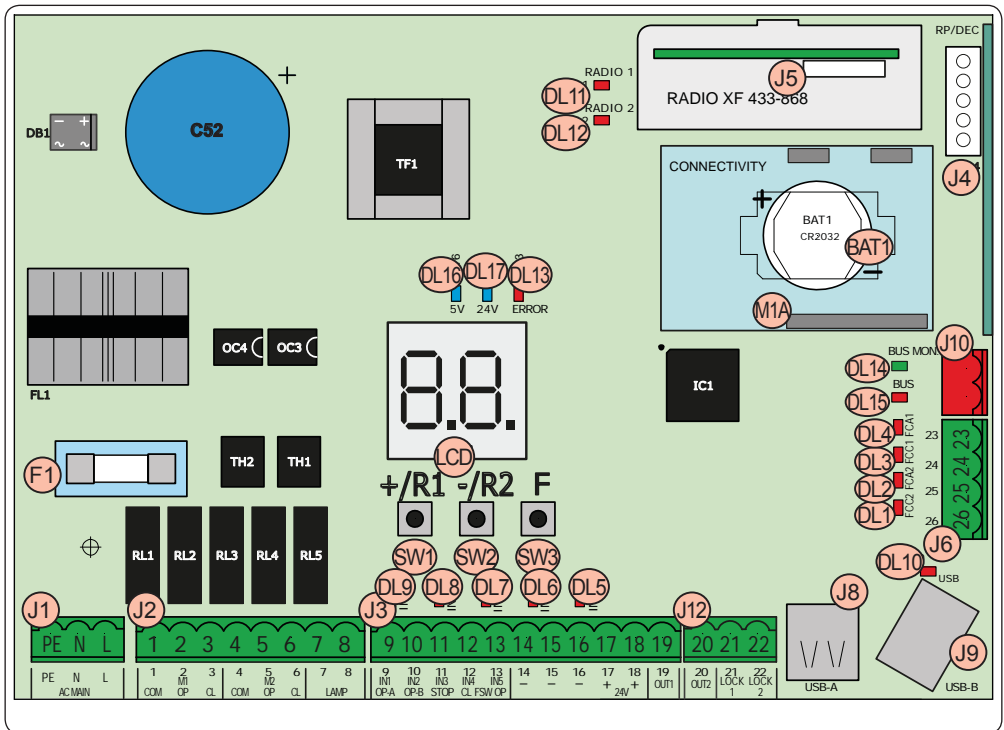

ENGLISH

LCD	Signalling/Programming display
SW1	“+R1” Programming button
SW2	“-R2” Programming button
SW3	“F” Programming button
DL1	“FCC2” Input status control LED
DL2	“FCA2” Input status control LED
DL3	“FCC1” Input status control LED
DL4	“FCA1” Input status control LED
DL5	“IN5” Input status control LED (default FSW OP)
DL6	“IN4” Input status control LED (default FSW CL)
DL7	“IN3” Input status control LED (default STOP)
DL8	“IN2” Input status control LED (default OPEN-B)
DL9	“IN1” Input status control LED (default OPEN-A)
DL10	“USB” Signalling LED
DL11	“RADIO1-XF” Signalling LED (OMNIDEC)
DL12	“RADIO2-XF” Signalling LED (OMNIDEC)
DL13	“ERROR” Error/alarm signalling LED
DL14	“BUS MON” BUS 2easy diagnostic signalling LED
DL15	Device signalling LED to BUS 2easy ACTIVE

DL16	Microprocessor power presence LED
DL17	+24V Accessories power supply presence LED
J1	90V~ a 260V~ Power supply connector
J2	Motors and flashing lamp power supply connector
J3	Input/Output connector
J4	Decoder/Minidec/RP Receiver connector: Channel 1 (Decoder/Minidec/RP) - OPEN A (Total Opening) Channel 2 (RP2) - OPEN B (Partial Opening)
J5	XF433/XF868 (OMNIDEC) receiver module connector Channel 1 - OPEN A (Total Opening) Channel 2 - OPEN B (Partial Opening)
J6	Limit switch input connector
J8	HOST USB-A for Mass Memories connector
J9	DEVICE USB-B for connection to PC/MAC connector
J10	BUS 2easy device connector
J12	OUT2 and LOCK 1-2 output connector
M1A	G-COM, WI-COM, Net-COM module connector
BAT1	CR2032 buffer battery for board date/time
F1	Motor and power supply safety fuse

4. ELECTRICAL CONNECTIONS

ENGLISH

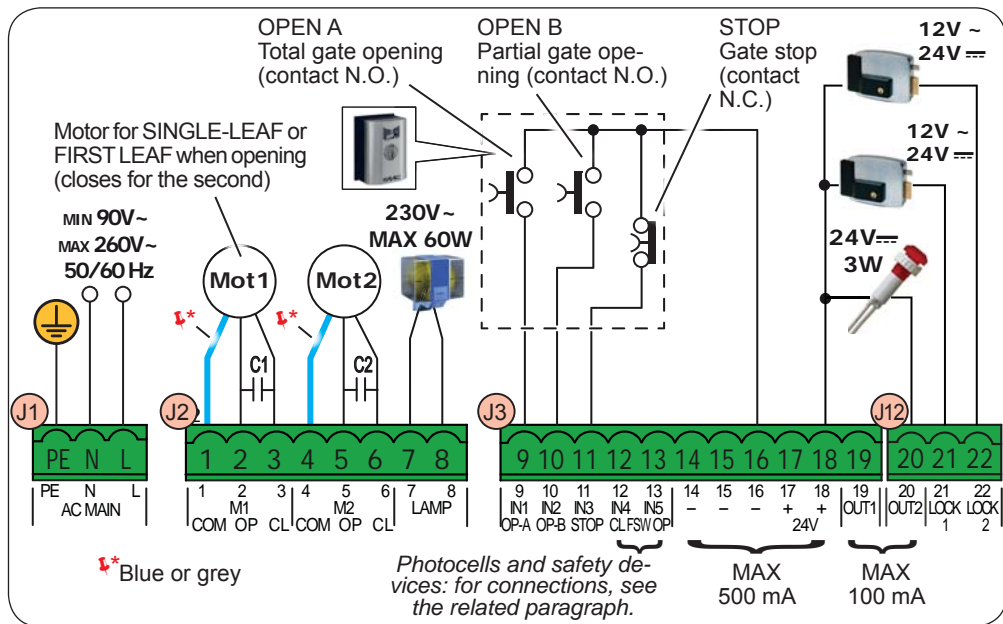

4.1 J1 - MAINS PRIMARY POWER SUPPLY

PE	Earthing Connection
N	Power Supply Connection from 90 V~ to 260 V~ Neutral
L	Power Supply Connection from 90 V~ to 260 V~ Line

⚠ For correct operation, you must connect the switching power supply to the system's earthing conductor. Ensure that upstream a suitable differential magnetothermic switch has been installed.

4.2 J2 - MOTORS AND FLASHING LAMP

1	M1 - COM	Common contact motor 1
2	M1 - OP	Opening phase motor 1
3	M1 - CL	Closing phase motor 1
4	M2 - COM	Common contact motor 2
5	M2 - OP	Opening phase motor 2
6	M2 - CL	Closing phase motor 2
7	LAMP	Flashing lamp connection (MAX 60 W)
8		

☞ M1 = first leaf when opening or single leaf
M2 = second leaf when opening - **CAN-NOT** be used for single leaf

☞ To verify correct wiring and direction of motor rotation, (see 5.4 TIME LEARNING - SETUP)

4.3 J3 - LOW-VOLTAGE ACCESSORIES - INPUTS/OUTPUTS

9	IN1	OPEN A contact - N.O. TOTAL opening	Connect a button or other pulse generator which, by closing a contact, commands TOTAL opening of both leaves.
10	IN2	OPEN B contact - N.O. PARTIAL opening	<p> on 2-motor systems = 100% of leaf 1 opening; on 1-motor systems = 50% of leaf 1 opening.</p> <p><u>When a logic requiring a CLOSE (b, bC, C) input is selected, the, OPEN B input automatically becomes CLOSE - N.O. (leaves closing command).</u></p>

To install more than one OPEN A or OPEN B pulse generator, connect the N.O. contacts in parallel (see related Fig.)

11	IN3	STOP contact - N.C.	Connect a button or other pulse generator which, by opening a contact, stops movement of the automated system .
----	-----	---------------------	------------------------------------------------------------------------------------------------------------------------

To install more than one STOP device, connect the N.C. contacts in series (see related Fig.). If stop devices are NOT connected, jumper the terminals STOP and GND.

12	IN4	FSW CL contact - N.C. closing safety	Connect a photocell or other device which, by opening a contact, reverses the movement of the automated system during opening (FSW OP) or during closing (FSW CL).
13	IN5	FSW OP contact - N.C. opening safety	

To install more than one safety device, connect the N.C. contacts in series (see related Fig.). If safety devices are NOT connected, jumper terminals IN4 and IN5 and GND if the FAIL-SAFE safety is not active; otherwise jumper IN4 and IN5 and OUT1 (FAIL-SAFE).

14	-	GND Accessories power supply negative
15		
16		
17	+	+24 Accessories power supply positive (MAX. load = 500mA)
18		
19	OUT1	24 V $\overline{\text{=}}$ (Open Collector) programmable using function $\square $ (advanced programming); default: always active .

 **Other programming options are available by programming via a PC/MAC (see dedicated instructions).**

Fig. e.g.: Connecting 2 N.O. contacts in parallel.

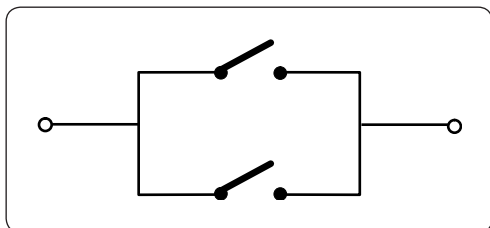
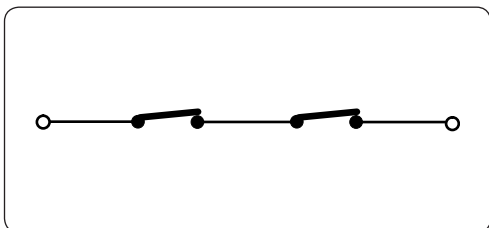

Fig. e.g.: Connecting 2 N.C. contacts in series.



4.4 J12 - PROGRAMMABLE OUTPUTS - ELECTRIC LOCKS

20	OUT2	24 V \equiv (Open Collector) programmable using the function o2 (advanced programming); default: indicator light	
21	LOCK 1	Electric lock (12 V \sim or 24 V \equiv) operated 2 sec before opening of leaf 1	When BUS 2easy encoder is disabled , the electric lock is operated before each opening (in whatever position the stopped leaf is in).
22	LOCK 2	Electric lock (12 V \sim or 24 V \equiv) - operated 2 sec before opening of leaf 2	When BUS 2easy encoder is enabled , the electric lock is operated only before opening the closed leaf.

 **Other programming options are available by programming via a PC/MAC (see dedicated instructions).**

4.5 J12 -J6 - LIMIT SWITCH AND GATECODER

The limit switch contacts FCC1, FCA1, FCC2, FCA2 are all NC contacts. They are programmable using the functions **FR** and **FC** (basic programming) ; default: **disabled**.

 **If no limit switches are used, you DO NOT need to jumper the limit switch contacts FCC1, FCA1, FCC2, FCA2.**

You can however use a single GATECODER (only for single leaf); in this case, you do not need to jumper the unused inputs to the earth.

Fig. Limit switch and GATECODER connections (maximum configuration: ③).

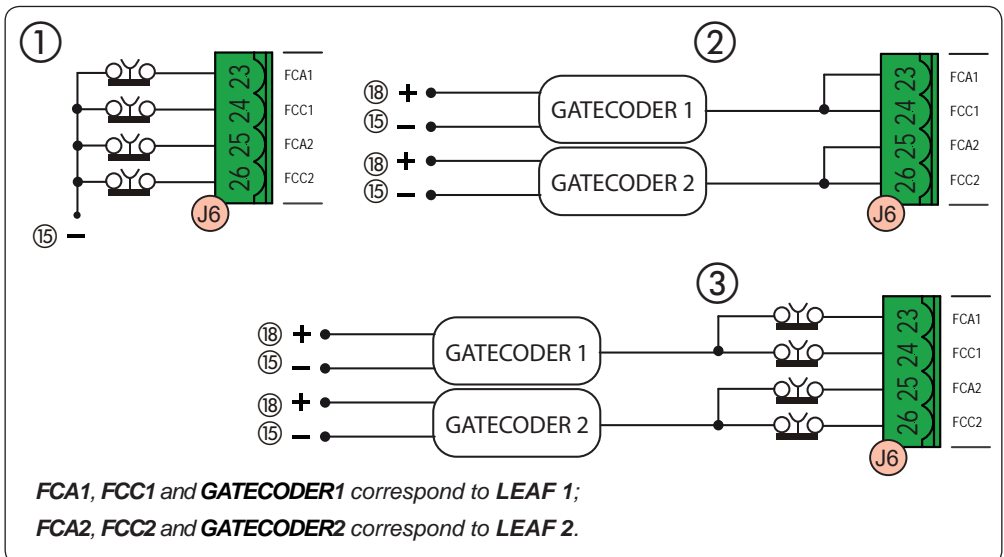

4.6 J10 - BUS 2EASY ACCESSORIES

This board features a **BUS2easy** circuit for facilitating connection to the safety devices of a high number of auxiliary BUS 2easy (MAX 16 pairs of photocells), encoder and control devices.

 **If no BUS 2easy accessories are used, leave the BUS 2easy connector free.**

BUS 2easy photocells

Before connecting the photocells, arrange them for the duly address assignment, depending on their position and operation mode:

Photocells during closing: trip only during the closing of the automated system - suitable for protecting the closing area from risk of impact.

Photocells during opening: trip only during the opening of the automated system - suitable for protecting the opening area from risk of impact.

Photocells during opening/closing: trip during both the opening and closing - suitable for protecting the entire movement area from risk of impact.

Pulse generators: used as pulse generators for opening the automated system.

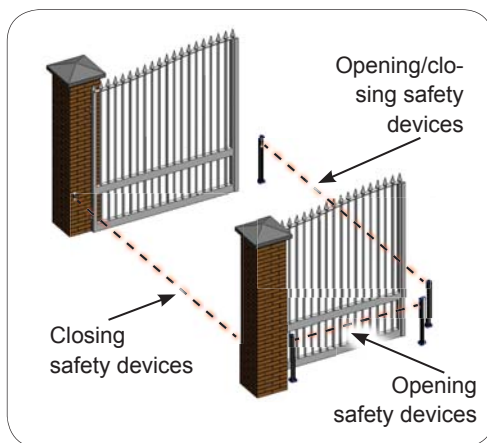

Address assignment of BUS 2easy photocells

To assign the address to each pair of photocells, you must set the Dip-Switches (**DS1**) located on the transmitter and corresponding receiver.

 **The transmitter and receiver of a pair of photocells must have the same DIP-SWITCH setting.**

Two or more pairs of photocells must not have the same DIP-SWITCH setting.

 **Other programming options are available by programming via a PC/MAC (see dedicated instructions).**

Dip1	Dip2	Dip3	Dip4	TYPE OF PHOTOCELLS
OFF	OFF	OFF	OFF	OPENING (max 6 pairs)
OFF	OFF	OFF	ON	
OFF	OFF	ON	OFF	
OFF	OFF	ON	ON	
OFF	ON	ON	OFF	CLOSING (max 7 pairs)
OFF	ON	ON	ON	
ON	OFF	OFF	OFF	
ON	OFF	OFF	ON	
ON	OFF	ON	OFF	
ON	OFF	ON	ON	
ON	ON	OFF	OFF	
ON	ON	OFF	ON	OPENING and CLOSING (max 2 pairs)
ON	ON	ON	OFF	
OFF	ON	OFF	OFF	OPEN PULSE (1 pair)
OFF	ON	OFF	ON	
ON	ON	ON	ON	

Connection of BUS 2easy photocells

For connecting you have to use two cables without polarity (see the specific device instructions).

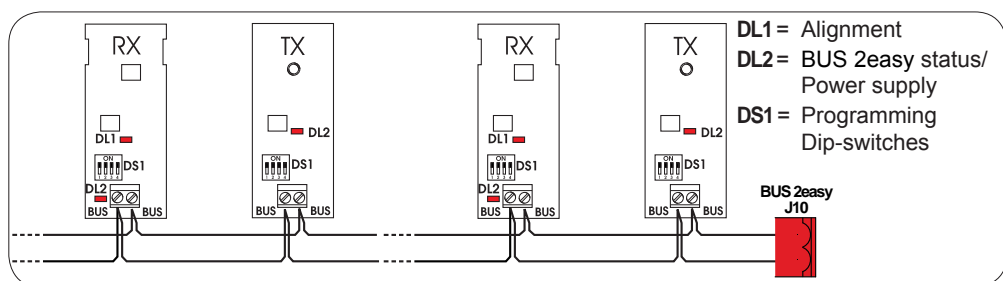

BUS 2easy encoder connection is done using the bi-polar cables supplied with.

Connection - Address assignment of BUS 2easy Encoder

⚠ *The polarity of the BUS 2easy line connection determines the correspondence of the encoder to one leaf or the other.*

pay careful attention to the indications of the status LEDs located on the body of each encoder.

LEAF 1 opens first and closes last.

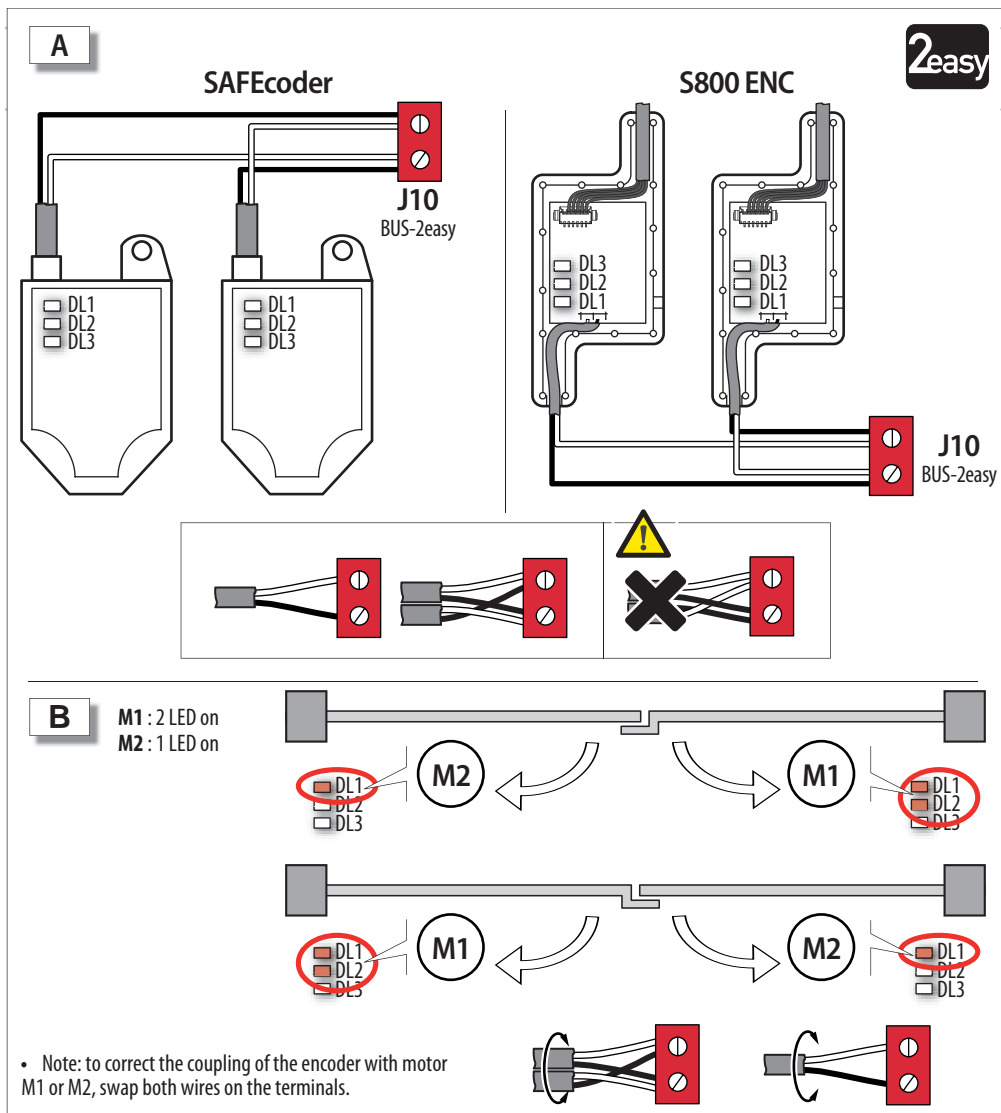

Tab. BUS 2easy Encoder LEDs Status

LED	ON	FLASHING	OFF
DL1	Power present Communication present	Power present Communication absent	Power absent Communication absent
	<i>DL1 must always be on to confirm correct encoder/board connection.</i>		
DL2	Leaf 1	/	Leaf 2
	<i>DL2 indicates the leaf on which the encoder is installed; it must be on for leaf 1 and off for leaf 2.</i>		
DL3	Stationary leaf	Leaf in motion	Stationary leaf
	<i>DL3 indicates pulse reading during leaf movement using steady flashing. In stationary status of the leaf, the DL3 can be either on or off.</i>		

 **In case of incorrect connection (DL2 on or off for both of the encoders), during the BUS 2easy accessories learning procedure, the DL1 leds of both encoders are FLASHING.**

4.7 J5 - XF MODULE RAPID CONNECTOR

Plug-in rapid connector dedicated to OMNIDEC 2-channel decoding module.

 **ALWAYS cut off power to the board BEFORE inserting/removing the module.**

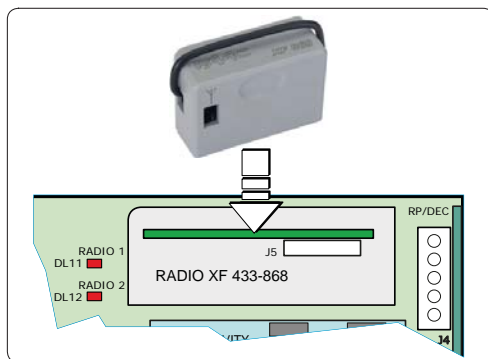

4.8 J14 - DECODER/MINIDEC/RP RAPID CONNECTOR

Rapid connector dedicated to Decoder/Minidec/RP/RP2.

Connect the accessory with the components facing inside the board.

 **ALWAYS cut off power to the board BEFORE inserting/removing plug-in boards.**

The RP2 2-channel receiver lets you control two different radio channels of the automated system (OPEN A and OPEN B/CLOSE) using a 2-channel radio control.

The 1-channel receiver (Decoder/Minidec/RP) lets you control only one radio channel: OPEN A.

 **Other programming options are available by programming via a PC/MAC (see dedicated instructions).**

4.9 M1A - MODULE RAPID CONNECTOR

Plug-in connector dedicated to G-COM, WI-COM, Net-COM modules.

 **ALWAYS cut off power to the board BEFORE inserting/removing the module.**

 **Other programming options are available by programming via a PC/MAC (see dedicated instructions).**

4.10 TRADITIONAL PHOTOCELLS

This board lets you use traditional photocells (contact N.C. with relay).

Before connecting the photocells, it is best to identify the operating type, which depends on the movement area they have to protect:

Closing photocells: trip only during the automated system closing - suitable for protecting the closing area from risk of impact.

Opening photocells: trip only during the automated system opening - suitable for protecting the opening area from risk of impact.

Photocells for opening/closing: trip during both the opening and closing - suitable for protecting the entire movement area from risk of impact.

Pulse generators: used as pulse generators for opening the automated system.

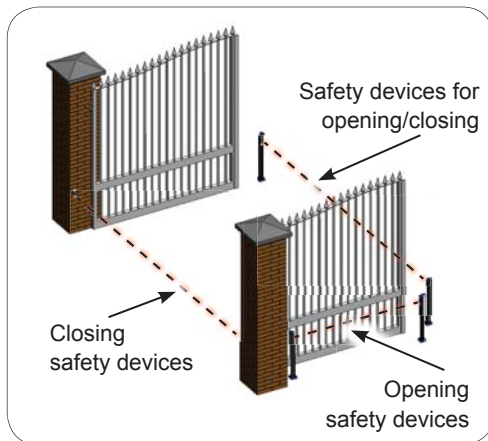

Fail Safe function

This function lets you monitor the correct alignment and operation of the photocells before each movement. To enable the Fail Safe function, enter the ADVANCED Programming and set the $\text{ol} = \text{O1}$ function.

 **With Fail Safe disabled:** connect the transmitter (TX) power supply to terminals 15 and 18 of J3.

With Fail Safe enabled: connect the power supply negative of the transmitters (TX) to OUT1. Then jumper the unused safety inputs with OUT1.

Hereafter are provided the drawings for some connection examples.

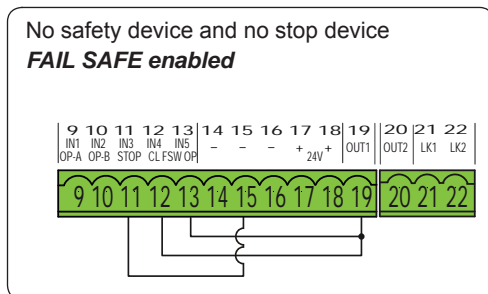
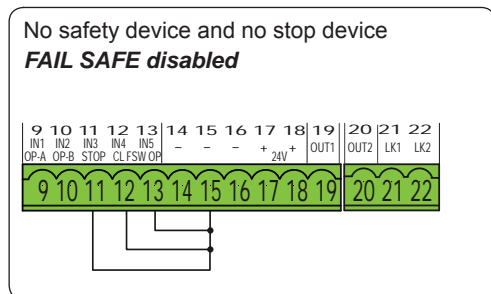

One closing safety device, one opening safety device, one STOP device.

FAIL SAFE disabled

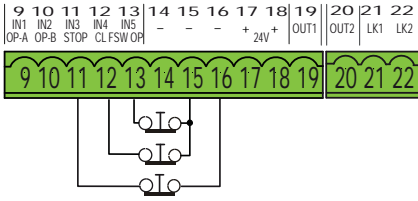

One closing safety device, one opening safety device, one STOP device.

FAIL SAFE enabled

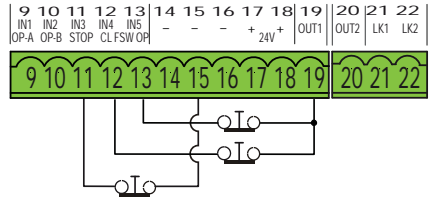

One pair of closing photocells.

FAIL SAFE disabled

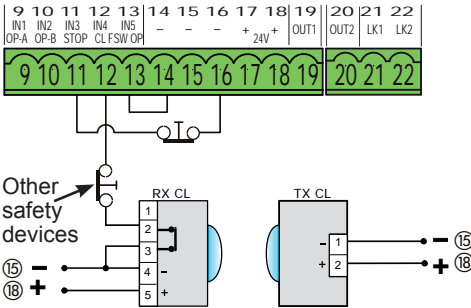

One pair of closing photocells, one pair of opening photocells and one pair for opening/closing.

FAIL SAFE disabled

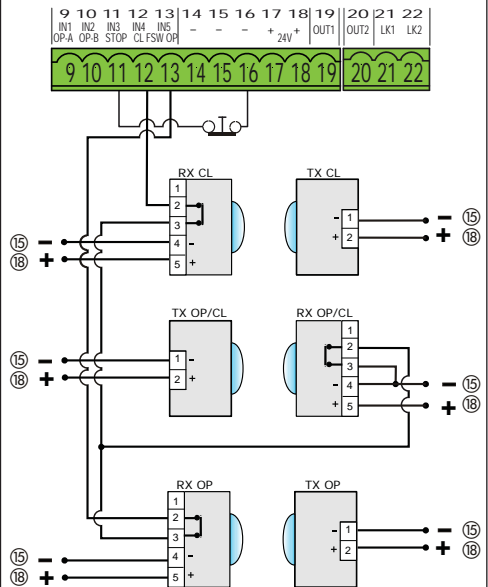

One pair of closing photocells.

FAIL SAFE enabled

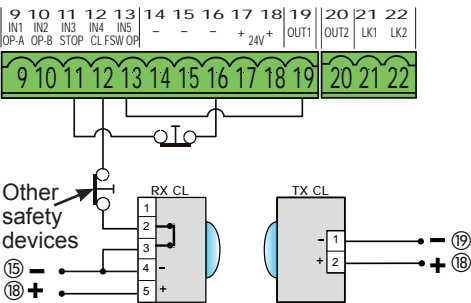

Two pairs of closing photocells.

FAIL SAFE disabled

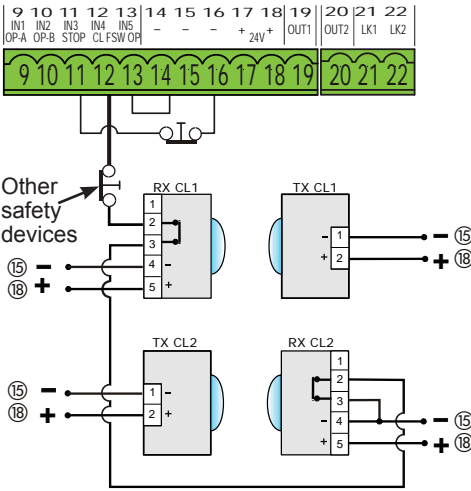

One pair of opening photocells and one for closing.

FAIL SAFE disabled

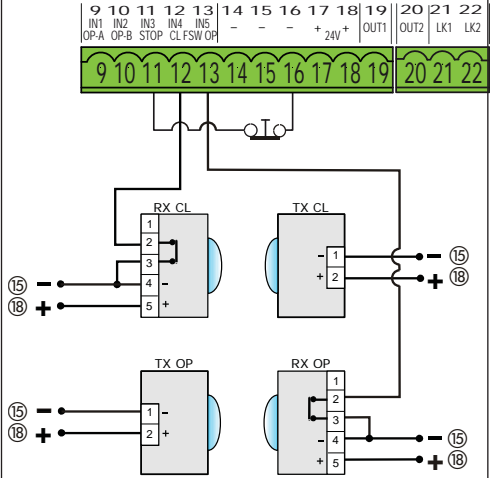

One pair of opening photocells.

FAIL SAFE disabled

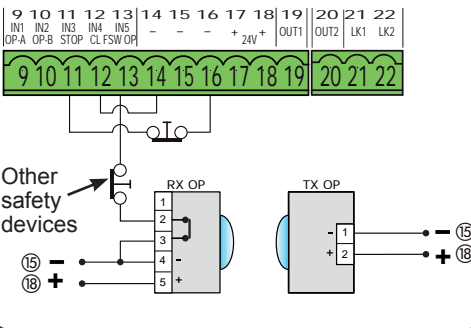

One pair of closing photocells and one for opening/closing.

FAIL SAFE disabled

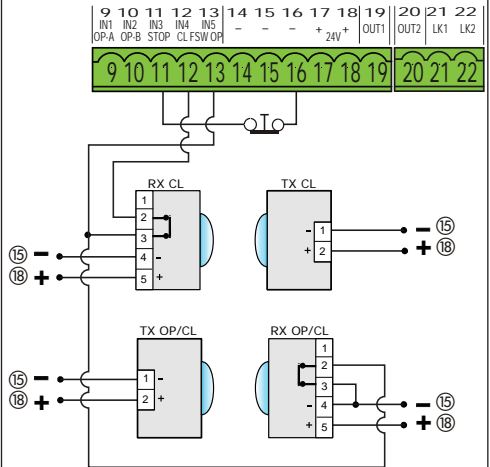

5. PROGRAMMING

Programming is divided in two levels:

- **BASIC programming**
- **ADVANCED programming**

The programming phases are (see **Tab.**):

1. to access PROGRAMMING (**1A** or **1B**);
2. to show the set values and modify them, if you want. *Changing the values is effective immediately, while the final memorisation must be carried out upon exiting programming (5t).*
3. exit the programming by using **5t** function. Select **y** to SAVE the configuration you just performed, otherwise select **no** to EXIT WITHOUT SAVING any changes.

You can **EXIT programming at anytime**:

- press and hold **F** and then also **-** to switch directly to **5t**.

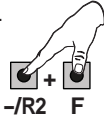

This board also allows **programming using a PC or MAC**.

This programming requires connection to PC/MAC via USB cable and USB-B relevant port.

The programming SOFTWARE with relevant instructions, must be downloaded from the website:

www.faacgroup.com

The programming using a PC/MAC, with the **default PASSWORD** does not inhibit the programming by board. The writing **PL** will be displayed in correspondence with the modified values. **Notes:** when you modify the values by board the previous PC/MAC programming will be overwritten.

The default password is **0000**.

*The programming using a PC/MAC, with a modified PASSWORD (different from the default one), will inhibit the programming by board. If one of the buttons is pressed, the display will show **PL** programming for 5 sec and changes will be allowed only by PC /MAC.*

Tab. BASIC programming phases.



1	2	3
<p>PRESS AND HOLD F: THE FIRST FUNCTION APPEARS </p>	<p>RELEASE F: THE FUNCTION VALUE IS DISPLAYED </p>	<p>USING + OR -, SCROLL THE AVAILABLE VALUES UNTIL THE DESIRED ONE +/R1 -/R2 </p>
	<p>PRESS F: TO MOVE TO THE NEXT FUNCTION </p>	<p>FUNCTION 5t (LAST FUNCTION) SELECT y TO SAVE THE PROGRAMMING OTHERWISE SELECT no TO EXIT THE PROGRAMMING WITHOUT SAVING</p>
		<p>PRESS THE BUTTON F TO CONFIRM; AT THE END THE DISPLAY RETURNS TO VISUALIZE THE AUTOMATED SYSTEM STATUS </p>

Tab. ADVANCED programming phases





1	2	3
<p>PRESS AND HOLD F AND THEN ALSO +: THE FIRST FUNCTION APPEARS </p>	<p>RELEASE THE BUTTONS: THE FUNCTION VALUE IS DISPLAYED </p>	<p>USING + OR -, SCROLL THE AVAILABLE VALUES UNTIL THE THE DESIRED ONE +/R1 -/R2 </p>
	<p>PRESS F: TO MOVE TO THE NEXT FUNCTION </p>	<p>FUNCTION 5t (LAST FUNCTION) SELECT y TO SAVE THE PROGRAMMING OTHERWISE SELECT no TO EXIT THE PROGRAMMING WITHOUT SAVING</p>
		<p>PRESS THE BUTTON F TO CONFIRM; AT THE END THE DISPLAY RETURNS TO VISUALIZE THE AUTOMATED SYSTEM STATUS </p>



THE FUNCTION IS DISPLAYED UNTIL YOU HOLD

5.1 BASIC PROGRAMMING FUNCTIONS

Display	Basic Function	Default
<p>CF</p>	<p>MOTOR TYPE:</p> <p>Displays and allows you to change the motor type set on the board:</p> <ul style="list-style-type: none"> 1 Motors for swing-leaf gates 2 Motors for sliding gates PC Mixed configuration from a PC/MAC (e.g.: a swing and a slide) <p> At the time of changing the set motor type on the board, the relevant defaults are uploaded.</p>	
<p>df</p>	<p>DEFAULT:</p> <ul style="list-style-type: none"> y indicates that all the set values correspond to the default values. no indicates that one or more set values are different from the default. <p>Set y if you want to restore the default settings.</p>	<p>y</p>
<p>LO</p>	<p>FUNCTION LOGICS:</p> <ul style="list-style-type: none"> E Semi-automatic EP Semi-automatic Step-by-Step ES Automatic Safety Devices ESA Automatic with reversal during pause ESP Automatic Step-by-Step Safety Devices AI Automatic 1 A Automatic AP Automatic Step-by-Step At Automatic timer b Semi-automatic "b" bC Mixed (Pulses for opening / Dead-man commands for closing) C Dead-man CU Logic modified from a PC/MAC <p> When a logic requiring a CLOSE (b, bC, C), input is selected, the OPEN B inputs will automatically be changed to CLOSE. , if you choose a logic that does not require the use of CLOSE inputs, these inputs will change to OPEN B. The simultaneous presence of CLOSE and OPEN B is possible only using the PC/MAC software.</p> <p><i>For a description of how the logics operate, see the related paragraph.</i></p>	<p>E</p>



Display	Basic Function	Default
<p>PA</p>	<p>PAUSE A TIME (visualised only with Automatic logics)</p> <p>Is the pause time in a TOTAL opening (it is enabled only if a logic with pause time has been selected).</p> <p>Adjustable from 00 to 59 sec, in 1-second steps.</p> <p>Next the value 59, the viewing changes to minutes and tenths of a second (separated by a decimal point) and time is adjusted in 10-second steps up to the maximum value of 9.5 minutes.</p> <p><i>e.g.: if the display shows 2.5, the time is 2 min and 50 sec.</i></p>	<p>30</p>
<p>Pb</p>	<p>PAUSE TIME B (visualised only with Automatic logics):</p> <p>Is the pause time in a PARTIAL opening (it is effective only if a logic with pause time has been selected).</p> <p>Adjustable from 00 to 59 sec, in 1-second steps.</p> <p>Next the value 59, the viewing changes to minutes and tenths of a second (separated by a decimal point) and time is adjusted in 10-second steps up to the maximum value of 9.5 minutes.</p> <p><i>Es: if the display shows 2.5, the time is 2 min and 50 sec.</i></p>	<p>30</p>
<p>Mn</p>	<p>NR. OF MOTORS:</p> <p>You can select the number of motors present in the system:</p> <p>1 = 1 motor</p> <p>2 = 2 motors</p> <p> <i>If the SETUP is performed with only one motor, and later two motors are used, the board will signal error 14 - configuration error, which can be deleted by repeating the SETUP with two motors or by returning to one motor.</i></p> <p><i>If a SETUP is performed with two motors and later only one is used, the board will not signal an error. Only the motor connected to input M1 will move.</i></p> <p><i>When programming from a PC/MAC, you can select different partial openings.</i></p>	<p>2 (swing-leaf)</p> <p>1 (sliding)</p>

Display	Basic Function	Default
F1	<p>MOTOR 1 POWER:</p> <p>You can adjust the maximum power of motor 1, which is the same during both opening and closing.</p> <p>01 = minimum power 50 = maximum power</p> <p> If the power is modified, we recommend performing a new SETUP - see the related paragraph.</p> <p>If hydraulic motors are used, power must be programmed to maximum level (50).</p>	25
F2	<p>MOTOR 2 POWER (visualised only with the function $\Pi_n = 2$):</p> <p>You can adjust the maximum power of motor 2, which is the same during both opening and closing.</p> <p>01 = minimum power 50 = maximum power</p> <p> If the power is modified, we recommend performing a new SETUP - see the related paragraph.</p> <p>If hydraulic motors are used, power must be programmed to maximum level (50).</p>	25
E _n	<p>ENCODER USE:</p> <p>You can enable/disable the use of encoders (both BUS and GATECODER encoders):</p> <p>Y = encoders on both motors no = encoders disabled</p>	no
FA	<p>LIMIT SWITCH WHEN OPENING (displayed only if function $CF = 1$ or $CF = PC$):</p> <p>Lets you set or disable use of the opening limit switch on swing-leaves .</p> <p> In case of mixed configuration ($CF = PC$) this function works only on the swing-leaves. The limit switch on the SLIDING leaf is required and determines when the leaf stops.</p> <p>no = opening limit switches disabled 01 = the limit switch determines the stopping of motion 02 = the limit switch determines the start of deceleration</p> <p> After having changed the value of this function, SETUP is required: the card will signal error 14 (configuration error) until the SETUP is performed again or until the previous value is restored</p>	no

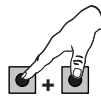
Display	Basic Function	Default
<p>FC</p>	<p>LIMIT SWITCH WHEN CLOSING (displayed only if function CF = 1 or CF = PC):</p> <p>Lets you set or disable use of the closing limit switch on swing-leaves.</p> <p> <i>In case of mixed configuration (CF = PC) this function works only on the swing-leaf. The limit switch on the SLIDING leaf is required and determines when the leaf stops.</i></p> <p>no = closing limit switches disabled 01 = the limit switch determines the stopping of motion 02 = the limit switch determines the start of deceleration</p> <p> <i>After having changed the value of this function, SETUP is required: the card will signal error 14 (configuration error) until the SETUP is performed again or until the previous value is restored.</i></p>	<p>no</p>
<p>Br</p>	<p>SLIDING LEAF BRAKING (displayed only if function CF = 2 or CF = PC):</p> <p>Lets you set the braking time of sliding leaves.</p> <p>00 = braking disabled 10 = maximum braking time</p>	<p>05</p>
<p>Cd</p>	<p>DELAY FOR CLOSING LEAF (visualised only with the function n = 2):</p> <p>Is the delay time for starting leaf 1 closing with respect to leaf 2. Makes it possible to avoid overlapping of the two leaves.</p> <p>Adjustable from 00 to 59 sec, in 1- second steps.</p> <p>Next the value 59, the viewing changes to minutes and tenths of a second (separated by a decimal point) and time is adjusted in 10-second steps up to the maximum value of 3 minutes.</p> <p><i>e.g.: if the display shows 1.2, the time is 1 min and 20 sec</i></p>	<p>05</p>
<p>bu</p>	<p>BUS 2easy DEVICES ENTRY:</p> <p><i>See the related paragraph.</i></p>	<p>no</p>

Display	Basic Function	Default														
n2	<p>MOTOR 2 dead-man DRIVE mode (visualised only with the function $n = 2$)</p> <p>+/R1 <input type="checkbox"/> OPENS (visualising oP) until the button is held down</p> <p>-/R2 <input type="checkbox"/> CLOSES (visualising cL) until the button is held down</p>	--														
n1	<p>MOTOR 1 dead-man DRIVE mode</p> <p>+/R1 <input type="checkbox"/> OPENS (visualising oP) until the button is held down</p> <p>-/R2 <input type="checkbox"/> CLOSES (visualising cL) until the button is held down</p>	--														
tL	<p>WORK TIME LEARNING (SETUP):</p> <p>See the related paragraph.</p>	--														
St	<p>AUTOMATED SYSTEM STATUS:</p> <p>You can exit programming, choosing whether or not to save the configuration you just performed.</p> <p>1. set the choice:</p> <p> y to SAVE and EXIT the programming</p> <p> no to EXIT the programming WITHOUT SAVING</p> <p>2. press the button F to confirm; at the end the display returns to visualize the automated system status:</p> <table border="0"> <tr> <td>00 = CLOSED</td> <td>07 = FAIL SAFE in progress</td> </tr> <tr> <td>01 = OPEN</td> <td>08 = checking BUS2easy devices in progress</td> </tr> <tr> <td>02 = Stationary then "OPENS"</td> <td>09 = Pre-flash then "OPENS"</td> </tr> <tr> <td>03 = Stationary then "CLOSES"</td> <td>10 = Pre-flash then "CLOSES"</td> </tr> <tr> <td>04 = In "PAUSE"</td> <td>11 = Emergency open</td> </tr> <tr> <td>05 = during Opening</td> <td>12 = Emergency close</td> </tr> <tr> <td>06 = during Closing</td> <td>HP = Hold position</td> </tr> </table> <p>⚠ WARNING If power is lost to the board prior to confirmation (step 2.), all changes made will be lost.</p> <p> You can EXIT programming at any time: press and hold F and then also - to switch directly to St.</p> <p>-/R2 F</p>	00 = CLOSED	07 = FAIL SAFE in progress	01 = OPEN	08 = checking BUS2easy devices in progress	02 = Stationary then "OPENS"	09 = Pre-flash then "OPENS"	03 = Stationary then "CLOSES"	10 = Pre-flash then "CLOSES"	04 = In "PAUSE"	11 = Emergency open	05 = during Opening	12 = Emergency close	06 = during Closing	HP = Hold position	y
00 = CLOSED	07 = FAIL SAFE in progress															
01 = OPEN	08 = checking BUS2easy devices in progress															
02 = Stationary then "OPENS"	09 = Pre-flash then "OPENS"															
03 = Stationary then "CLOSES"	10 = Pre-flash then "CLOSES"															
04 = In "PAUSE"	11 = Emergency open															
05 = during Opening	12 = Emergency close															
06 = during Closing	HP = Hold position															



5.2 ADVANCED PROGRAMMING FUNCTIONS



Display	Advanced Function	Default
bo	<p>TIME OF MAXIMUM POWER AT STARTING:</p> <p>You can set the starting time. During start the motors work at maximum power for starting the movement. Adjustable from 00 to 10 sec, in 1-second steps (ignoring the power level selected with F1 and F2).</p>	01
cs	<p>FINAL STROKE WHEN CLOSING (RAM STROKE) (NOT displayed if function FC = 1):</p> <p>Lets you enable/disable the ram stroke on swing-leaves.</p> <p>The ram stroke facilitates latching of the electric lock by activating the motors at maximum power during final closing.</p> <p>Y = enabled (for 2 sec) no = disabled</p> <p> <i>In case of systems with an absolute encoder, to enable this function a setup must be performed using the automatic leaf stop on the mechanical contact point.</i></p>	no
rs	<p>REVERSE STROKE WHEN OPENING displayed if function FC = 1):</p> <p>Lets you enable/disable the reverse stroke on leaf doors.</p> <p>The reverse stroke facilitates unlatching of the electric lock. When the automatic system is closed, before starting to open, the motors give a brief push to close.</p> <p>Y = enabled (for 2 sec) no = disabled</p> <p> <i>In case of systems with an absolute encoder, to enable this function a setup must be performed using the automatic leaf stop on the mechanical contact point.</i></p>	no

Display	Advanced Function	Default
0d	<p>DELAY FOR OPENING LEAF (visualised only with the function $\Pi_n = 2$):</p> <p>You can set the delay time for starting leaf 2 opening with respect to leaf 1, in order to avoid overlapping of the two leaves.</p> <p>Adjustable from 00 to 59 sec, in 1- second steps.</p> <p>Next the value 59, the viewing changes to minutes and tenths of a second (separated by a decimal point) and time is adjusted in 10-second steps up to the maximum value of 1.3 minutes.</p> <p><i>e.g.: if the display shows 1.2, the time is 1 min and 20 sec.</i></p>	02
r1	<p>LEAF 1 DECELERATION:</p> <p>You can adjust the deceleration space as a percentage of the total travel of leaf 1.</p> <p>Adjustable from 00 to 99 %, in 1% steps.</p> <p>00 = no deceleration 01 = minimum deceleration space 99 = maximum deceleration space</p>	20
r2	<p>LEAF 2 DECELERATION (visualised only with the function $\Pi_n = 2$):</p> <p>You can adjust the deceleration space as a percentage of the total travel of leaf 2.</p> <p>Adjustable from 00 to 99 %, in 1% steps.</p> <p>00 = no deceleration 01 = minimum deceleration space 99 = maximum deceleration space</p>	20
PF	<p>PRE-FLASHING:</p> <p>You can enable/disable the pre-flashing. Pre-flashing duration = 3 sec.</p> <p>You can choose:</p> <p>00 = disabled 0C = pre-flashing before each movement CL = pre-flashing before a closing movement OP = pre-flashing before an opening movement PA = pre-flashing only at the end of the pause time</p>	00

Display	Advanced Function	Default
Ph	<p>CLOSING PHOTOCELLS:</p> <p>The intervention of closing photocells causes the reversing of automated system (opening). You can choose:</p> <p>Y = operate the reversal only after the photocells are released no = operate the reversal immediately</p>	no
Ad	<p>ADMAP FUNCTION:</p> <p>Allows operation in compliance with French regulation NFP 25/362.</p> <p>Y = enabled no = disabled</p>	no
EC	<p>ANTI-CRUSHING SENSITIVITY (visualised only with the function $\epsilon_n = Y$):</p> <p>Varying this function varies the amount of time after which, in case of obstacle, the board commands reversal of the leaves, or it will command a stop if the leaves are in the contact point search space (see the parameter r8). The fourth consecutive obstacle detected in the same direction and position will be defined as a contact point and the leaf will stop in that position.</p> <p>00 = minimum sensitivity (maximum time before reversal) 10 = maximum sensitivity (minimum time before reversal)</p>	05
r8	<p>MECHANICAL STOP SEARCH ANGLE (displayed only if function $\epsilon_n = Y$ and functions F_c and $FA = no$ or $= 02$):</p> <p>You can adjust the contact point search angle within which the board will stop movement without reversing, if it encounters an obstacle or the contact point.</p> <p>Adjustable from 0.3 to 20 degrees. From 0.3 to 9.9 degrees, adjustments are made in 0.1 degree steps. From 10 to 20 degrees, adjustments are made in 1 degree steps.</p>	4.0
tA	<p>ADDITIONAL OPERATING TIME (displayed only if function $\epsilon_n = no$ and functions F_c and $FA = no$ or $= 02$):</p> <p>You can add a work time at the end of movement. Adjustable from 0 to 30 sec in 1 sec steps.</p> <p> This time is not considered when calculating the deceleration percentage.</p>	03

Display	Advanced Function	Default
01	<p>OUT 1:</p> <p>You can set the output OUT1 (open collector N.O.) in one of the following functions:</p> <p>00 = always active 01 = FAIL-SAFE 02 = INDICATOR LIGHT (off = closed; on = during opening and open/ in pause; flashing = during closing) 03 = COURTESY LIGHT (stays on for the duration of the movement (even in SETUP) in addition to the set time of function t1) 04 = ACTIVE ERROR 05 = automated system OPEN or in PAUSE 06 = automated system CLOSED 07 = automated system MOVING 08 = automated system in EMERGENCY 09 = automated system in OPENING 10 = automated system in CLOSING 11 = <i>DISABLED</i> 12 = safety device ACTIVE 13 = TRAFFIC LIGHT function (active when OPENING and with automated system OPEN) 14 = timed output which can be activated from the second radio channel OMNIDEC (see function t1) 15 = output which can be activated from the second radio channel OMNIDEC (step-by-step function) 16 = active during movement of leaf 1 17 = active during movement of leaf 2 18 = active during breach alarm</p> <p> If tr is displayed, it indicates that the output is used as a TIMER set from the PC/MAC software.</p>	00
t1	<p>OUT 1 TIMING (visualised only with the function 01 = 03 or 01 = 14):</p> <p>You can adjust the timing of OUT 1 output if a timed function has been selected with a time from 1 to 59 minutes in 1-minute steps for functions 03-14 and from 1 to 59 sec in 1-second steps for function 11</p>	02
02	<p>OUT 2:</p> <p>You can set the output OUT2 (open collector N.O.).</p> <p>See the options as 01.</p>	02
t2	<p>OUT 2 TIMING (visualised only with the function 02 = 03 or 02 = 14):</p> <p>Adjustable as for t1.</p>	02

Display	Advanced Function	Default
AS	<p>MAINTENANCE REQUEST - CYCLE COUNTER (linked to the subsequent two functions):</p> <p>You can enable the signaling of maintenance request, or the cycle counter.</p> <p>y = enable the SIGNALING when the programmed number of cycles has been reached (as defined in subsequent two functions nc and nd). Signaling consists of a pre-flashing of 8 sec (in addition to the time may already be set with the function PF) before each movement.</p> <p> <i>If using a PC/MAC a maintenance request is set with a number of cycles greater than 99,990, the subsequent two functions nc and nd will display 99 and 99, respectively.</i></p> <p>no = enable the CYCLE COUNTER, that will be displayed in the subsequent two functions nc and nd up to a displayed maximum of 99,990.</p> <p> <i>If the number of cycles performed is greater than 99,990 the subsequent two functions nc and nd will display 99 and 99, respectively.</i></p>	no
nc	<p>CYCLE PROGRAMMING (THOUSANDS):</p> <p>If AS = y the display will show the number of thousands of cycles after which the signaling of maintenance request begins (can be set from 0 to 99).</p> <p>If AS = no the display will show the number of thousands of work cycles performed. The value displayed is updated with the succession of the cycles, interacting with the value in nd.</p> <p> <i>When AS = no you can reset the cycle counter: press simultaneously + and - for 5 sec.</i></p>	00

Display	Advanced Function	Default														
<p>nd</p>	<p>CYCLE PROGRAMMING (TENS):</p> <p>If AS = y the display will show the number of tens of cycles after which the signaling of maintenance request begins (can be set from 0 to 99).</p> <p>If AS = no the display will show the number of tens of work cycles performed. The value displayed is updated with the succession of the cycles, interacting with the value in nc.</p> <p> e.g.: if the system has performed 11,218 cycles, nc = 11 and nd = 21 will be displayed</p>	<p>00</p>														
<p>St</p>	<p>AUTOMATED SYSTEM STATUS:</p> <p>You can exit programming, choosing whether or not to save the configuration you just performed.</p> <ol style="list-style-type: none"> set the choice: <ul style="list-style-type: none"> y to SAVE and EXIT the programming no to EXIT the programming WITHOUT SAVING press the button F to confirm; at the end the display returns to visualize the automated system status: <table border="0" data-bbox="176 699 949 912"> <tr> <td>00 = CLOSED</td> <td>07 = FAIL SAFE in progress</td> </tr> <tr> <td>01 = OPEN</td> <td>08 = checking BUS2easy devices in progress</td> </tr> <tr> <td>02 = Stationary then "OPENS"</td> <td>09 = Pre-flash then "OPENS"</td> </tr> <tr> <td>03 = Stationary then "CLOSES"</td> <td>10 = Pre-flash then "CLOSES"</td> </tr> <tr> <td>04 = In "PAUSE"</td> <td>11 = Emergency open</td> </tr> <tr> <td>05 = Opening</td> <td>12 = Emergency close</td> </tr> <tr> <td>06 = Closing</td> <td>HP = Hold position</td> </tr> </table> <p> WARNING If power is lost to the board prior to confirmation (step 2.), all changes made will be lost.</p> <p> You can EXIT programming at any time: press and hold F and then also = to switch directly to St.</p> <p>-/R2 F</p>	00 = CLOSED	07 = FAIL SAFE in progress	01 = OPEN	08 = checking BUS2easy devices in progress	02 = Stationary then "OPENS"	09 = Pre-flash then "OPENS"	03 = Stationary then "CLOSES"	10 = Pre-flash then "CLOSES"	04 = In "PAUSE"	11 = Emergency open	05 = Opening	12 = Emergency close	06 = Closing	HP = Hold position	<p>y</p>
00 = CLOSED	07 = FAIL SAFE in progress															
01 = OPEN	08 = checking BUS2easy devices in progress															
02 = Stationary then "OPENS"	09 = Pre-flash then "OPENS"															
03 = Stationary then "CLOSES"	10 = Pre-flash then "CLOSES"															
04 = In "PAUSE"	11 = Emergency open															
05 = Opening	12 = Emergency close															
06 = Closing	HP = Hold position															

5.6 BUS 2EASY DEVICE INSTALLATION

You can add BUS 2easy devices to the system at any time, proceeding as follows:

1. Cut off the electrical power to the board.
2. Install and set the BUS 2easy accessories according to the instructions of the devices.
3. Connect the BUS 2easy devices according to the instructions of Chapter **ELECTRICAL CONNECTIONS**.
4. Power up the board.
5. Complete the procedure for BUS 2easy device entry.

5.6.1 BUS 2easy DEVICE ENTRY

1. Access BASIC programming and scroll through the functions up until **b_u**. When **F** is released, the display will show the BUS 2easy devices status (see the figure).
2. Perform the entry: simultaneously press and hold **+** and **-** for at least 5 sec (during this time, the display will blink).
3. **u** will appear as a confirmation of entry completion.
4. Release the **+** and **-** buttons. The status of the BUS 2easy devices will be displayed.

 If no BUS device has ever been entered in the board, the display will read **no**.

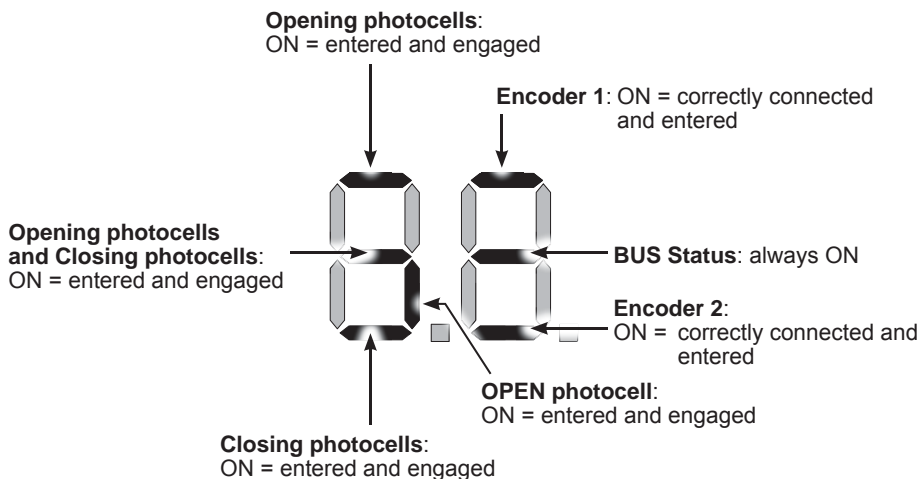
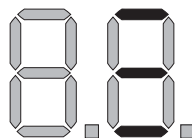

Fig. Visualising the BUS 2easy status in the function **b_u**: each segment of the display shows one type of device.

Fig. examples of BUS 2easy status visualization on display.

In STAND BY (gate closed and in stand-by) with BUS 2easy **Encoder** on leaf 1 and leaf 2 and BUS 2easy **Photocells** correctly connected and entered.



In case of BUS 2easy **Encoder** on leaf1 and leaf 2 and BUS 2easy **Photocells** correctly connected and entered and with closing photocells engaged:



Checking the securing devices entered on the board

To verify the types of BUS device recognised through the entry:

1. Press and hold the **+** button during stand-by visualisation; the segments corresponding to at least one entered device will go ON. E.g.:

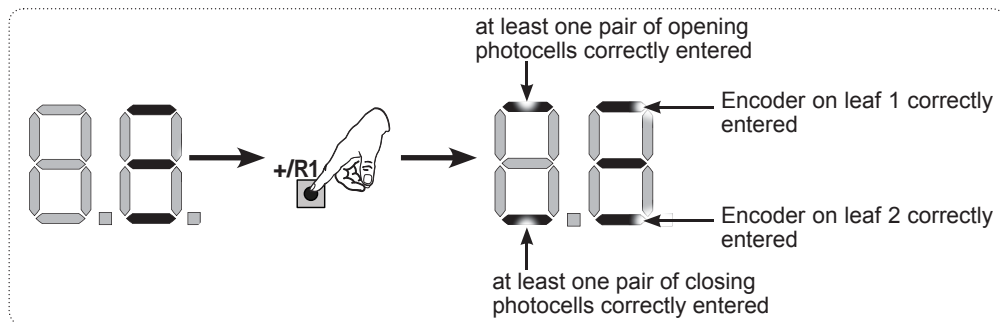

To check the condition of the BUS 2easy connection, verify the LED on the board:

LED DL15 (Red)

ON	Safety device engaged or pulse generator active
OFF	NO safety device engaged neither pulse generator active

LED DL14 (Green)

ON steady	Normal activity (led ON even if there are no devices).
Slow blinking (blink every 2,5 sec)	BUS 2easy line short-circuit.
Rapid blinking (blink every 0.5 sec)	Error in the BUS 2easy connection. Repeat the device entry. If the error occurs again, check: - That there are no more than one device in the system with the same address. - Calling error (number > or < the connected BUS devices). - FAIL SAFE error on the BUS device.
OFF	Board in Sleep mode (if used).

5.4 TIME LEARNING - SETUP

When the board is powered, if a SETUP has never been performed, or if the board requests it, on the display **S0** indicates that a SETUP must be performed.

 During SETUP, the connected BUS 2easy accessories are always entered.

 The BUS 2easy encoders are to be enabled before SETUP: set the parameter **En = 4** (see BASIC Programming)

For SETUP, proceed as follows:

 **During SETUP all safety devices are disabled! Therefore, carry out the operation avoiding any transit in the leaf movement area.**

 If a system without an encoder is installed, mechanical stops will be required for the leaves.

1. Enter BASIC programming and go to the parameter **EL**, when F is released **--** will appear.

2. Ensure that the gate leaves are closed. Otherwise, proceed as follows:

- Press and hold **-/R2** to close leaf 2

- Press and hold **+/R1** to close leaf 1

 Should pressing **+/R1** and/or **-/R2** command opening of the corresponding leaf, cut off power and, on terminal board J2, invert the phase cables of the corresponding motor (terminals 2-3 for leaf 1 motor and terminals 5-6 for leaf 2 motor).

3. With the gate leaves closed, launch SETUP by pressing and holding **+** and **-** until **S1** begins to flash on the display (about 3 sec).

4. Release **+** e **-**. Leaf 1 begins its opening movement.

Operation WITHOUT Encoder

Stop movement by sending an OPEN A pulse as soon as leaf 1 reaches the contact point.

Operation WITH Encoder

Leaf 1 will stop as soon as it reaches the contact point. If there is no mechanical stop, stop the leaf movement at the desired point by sending an OPEN A pulse.

5. On the display **S2** will flash (only if 2 motors have been selected): leaf 2 begins opening.

Operation WITHOUT Encoder

Stop movement by sending an OPEN A pulse as soon as leaf 2 reaches the contact point.

Operation WITH Encoder

Leaf 2 will stop as soon as it reaches the contact point. If there is no mechanical stop, stop the leaf movement at the desired point by sending an OPEN A pulse.

Steps 4 and 5 with function FA :

FA = 01 (the limit switch determines the stopping of motion) the OPEN A pulse for stopping motion is ignored.

FA = 02 (the limit switch determines the start of deceleration) send an OPEN A pulse only after involving the opening limit switch.

6. On the display **53** will flash (only if 2 motors have been selected): leaf 2 begins closing.

Operation WITHOUT Encoder

Stop movement by sending an OPEN A pulse as soon as leaf 2 reaches the contact point.

Operation WITH Encoder

Leaf 2 will stop as soon as it reaches the contact point. If there is no mechanical stop, stop the leaf movement at the desired point by sending an OPEN A pulse.

7. On the display **54** flashes: leaf 1 begins closing.

Operation WITHOUT Encoder

Stop movement by sending an OPEN A pulse as soon as leaf 1 reaches the contact point.

Operation WITH Encoder

Leaf 1 will stop as soon as it reaches the contact point. If there is no mechanical stop, stop the leaf movement at the desired point by sending an OPEN A pulse.

Steps 6 and 7 with function **FC** :

FC = 01 (the limit switch determines the stopping of motion) the OPEN A pulse for stopping motion is ignored.

FC = 02 (the limit switch determines the start of deceleration) send an OPEN A pulse only after involving the closing limit switch.

SET-UP for SLIDING LEAFS (**CF = 02**)

Steps 4, 5, 6 and 7 :

the leaf stop is determined by the limit switch. Any OPEN A impulses are ignored.

8. The board will automatically exit the programming menu and will display the automated system status (**00**) to confirm that the SETUP procedure has been completed correctly. If the procedure is not completed correctly, on the display **50** will start flashing, indicating that a new SETUP procedure must be performed.

 The deceleration spaces can be configured and modified from the display using the parameters **r1** and **r2** (see Advanced Programming) without repeating the SETUP.

5.5 TESTING THE AUTOMATED SYSTEM

Once installation and programming is completed, ensure that the system is operating correctly. Be especially careful that the safety devices operate correctly and ensure that the system complies with all current safety regulations. Close the cover in the provided seat with gasket.

6. MEMORISING THE RADIO CODE

The control board features an integrated 2-channel decoding system (DS, SLH/SLH LR, RC) called OMNIDEC. This system lets you memorise, using an additional receiver module (on J5 connector) and more radio controls having different technology but the same frequency. You can thus control both total opening (OPEN A) and partial opening (OPEN B).

 The different types of radio code (DS, SLH/SLH LR, LC/RC) can coexist simultaneously on the two channels. You can enter up to 1600 radio codes divided between OPEN A and OPEN B/CLOSE.

To use different encoding systems on the same channel, you must complete the learning of each encoding system and then repeat the procedure for the other one.

Other, more detailed, programming options are available using a PC/MAC (see dedicated PC/MAC instructions). For example, you can set an automatic OPEN command on the radio channel to command an automatic cycle (open-pause-close) regardless of the selected logic.

 **Keep the remote control at least 30 cm from the receiver.**

6.1 MEMORISING THE SLH/SLH LR RADIO CONTROLS

- Press and hold +/R1 - SW1 (OPEN A programming) or -/R2 - SW2 (OPEN B/CLOSE programming).
- After keeping the button pressed for about 5 sec, the corresponding radio LED (DL11 or DL12) will begin to flash slowly for about 20 sec.
- Release the button.
- Simultaneously press and hold P1 and P2 on the SLH/SLH LR radio control (only MASTER radio control).
 - The radio control LED will begin to flash.
- Release both buttons.
- Ensure that LED DL11 or DL12 on the board is still flashing (see point 2) and, while the radio control LED is still flashing, press and hold the desired button on the radio control (the radio control LED will go on steady).
- The corresponding LED on the board (DL11 or DL12) will go on steady for 1 sec and then go off, indicating that memorisation has been completed.
- Release the radio control button.
- To complete memorisation, press the button of the memorised radio control twice in succession.
 - The automated system will perform an opening cycle.

 **Ensure that there are no obstacles (by people or things) during the automated system movement.**

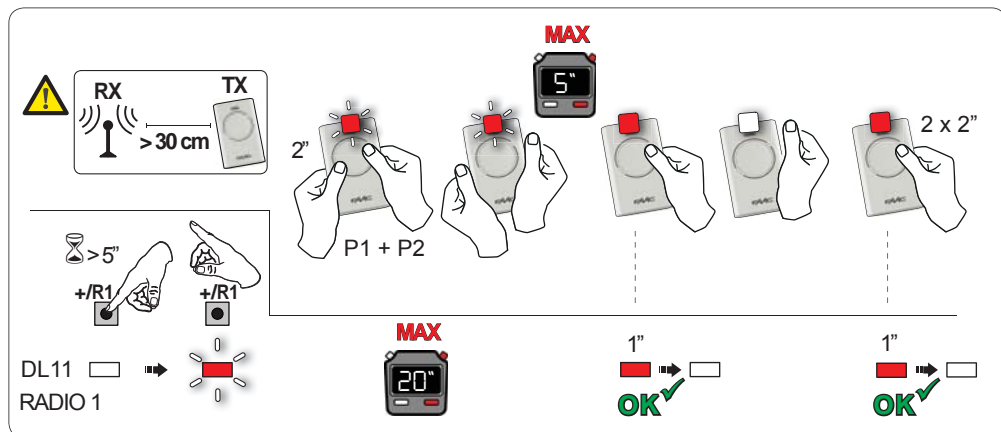

To enable other radio controls with the same system code, you must transfer the system code of the memorised radio control button to the button corresponding to the radio control you wish to add:

1. Simultaneously press and hold P1 and P2 on the memorised radio control.
 - The radio control LED will begin to flash.
2. Release both buttons.
3. Press and hold, while the radio control LED is still flashing, the memorised button (the radio control LED will go on steady).
4. Bring the radio controls close together, press and hold the corresponding button of the radio control you wish to add, and release only after the radio control LED flashes twice, indicating that memorisation has been completed.
5. Press the button of the memorised radio control twice in succession.
 - The automated system will perform an opening cycle.

⚠ Ensure that there are no obstacles (by people or things) during the automated system movement.

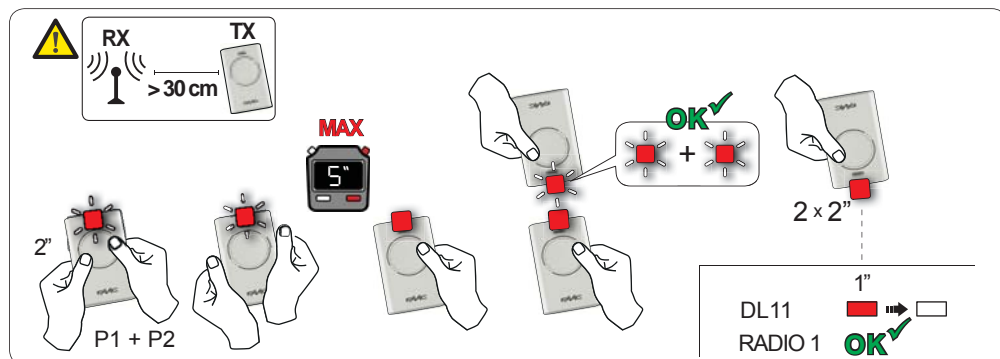

6.2 MEMORISING LC/RC RADIO CONTROLS (ONLY 433 MHZ)

1. Press and hold +/R1 - SW1 (OPEN A programming) or -/R2 - SW2 (OPEN B/CLOSE programming).
 - After keeping the button pressed for about 5 sec, the corresponding radio LED (DL11 or DL12) will begin to flash slowly for about 20 sec.
2. Release the button.
3. During radio LED flashing, press the desired button of the LC/RC radio control.
 - The corresponding LED on the board (DL11 or DL12) will go on steady for 1 second, indicating that memorisation has been completed, and will begin flashing again for another 20 sec during which you can memorise another radio control.
 - When the 20 sec have elapsed, the LED will turn off, indicating that the procedure has been completed.
4. To add other radio controls, repeat the procedure from point 1.

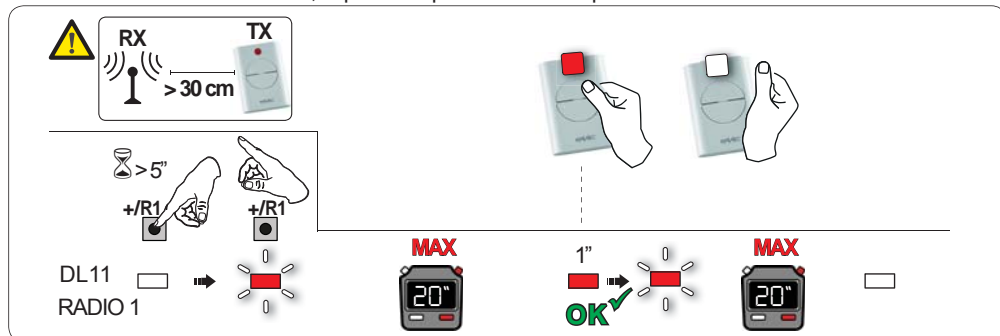

6.2.1 REMOTE MEMORISATION OF LC/RC RADIO CONTROLS

With LC/RC radio controls you can remotely memorise other radio controls, i.e. without working directly on the board, using a previously memorised radio control.

1. Take a radio control that has already been memorised on one of the 2 channels (OPEN A or OPEN B/CLOSE) and move to the vicinity of the board.
2. Simultaneously press and hold P1 and P2 until both LEDs flash slowly for 5 sec.
3. Within 5 seconds, press the previously memorised radio control button to activate the learning phase for the selected channel.
4. The LED on the board corresponding to the channel in learning mode will flash for 20 sec within which another radio control code is transmitted by pressing the button.
 - The corresponding LED on the board will go on steady for 2 sec (indicating that memorisation has been completed) and will begin flashing again for another 20 sec, during which you can memorise other radio controls, and will finally go off.

6.3 MEMORISING DS RADIO CONTROLS

1. On the DS radio control, choose the desired ON - OFF combination of the 12 dip-switches.
2. Press and hold +/R1 - SW1 (OPEN A programming) or -/R2 - SW2 (OPEN B/CLOSE programming).
 - After keeping the button pressed for about 5 sec, the corresponding radio LED (DL11 or DL12) will begin to flash slowly for about 20 sec.
3. Release the button.
4. During radio LED flashing, press the button of the radio control you wish to program.
 - The corresponding LED on the board (DL11 or DL12) will go on steady for 1 second and then go off, indicating that memorisation has been completed.
5. To add other different codes, repeat the procedure starting from point 1.
6. To add other radio controls with the same code, set the 12 dip-switches according to the same combination as the already memorised radio control.

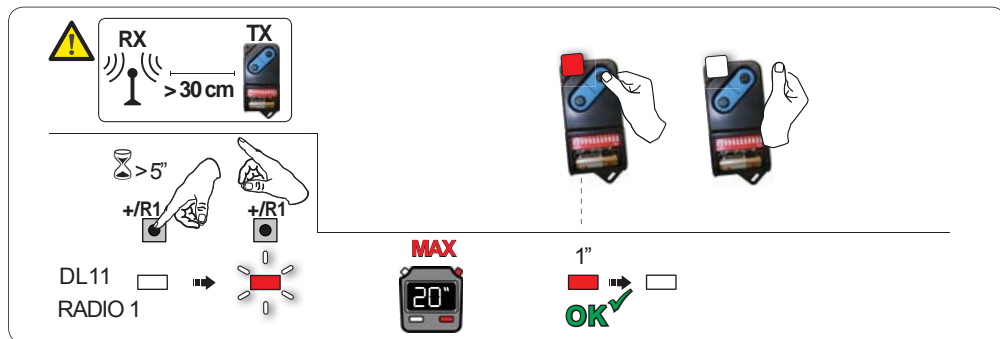

6.4 DELETING THE RADIO CONTROLS

 **This operation CANNOT be reversed. This will delete ALL the radio control codes memorised as both OPEN A and OPEN B/CLOSE. The cancellation procedure is active only in gate status visualisation mode.**



1. Press and hold -/R2 .
 - After pressing for about 5 sec, the DL12 LED begins to flash slowly; after another 5 sec of slow flashing and holding, the LEDs DL11 and DL12 begin flashing more rapidly (cancellation has started).
 - Once rapid flashing has stopped, LEDs DL11 and DL12 will go on steady, confirming the cancellation of all the radio codes (OPEN A and OPEN B/CLOSE) from the board memory.

2. Release -/R2 . The LEDs will go off, indicating correct cancellation.



7. START-UP

7.1 CHECKING THE LEDs

After having made all the connections and powered the board, check the status of the LEDs in relation to the status of the inputs (the Figure shows the condition of closed automated system).

ENGLISH

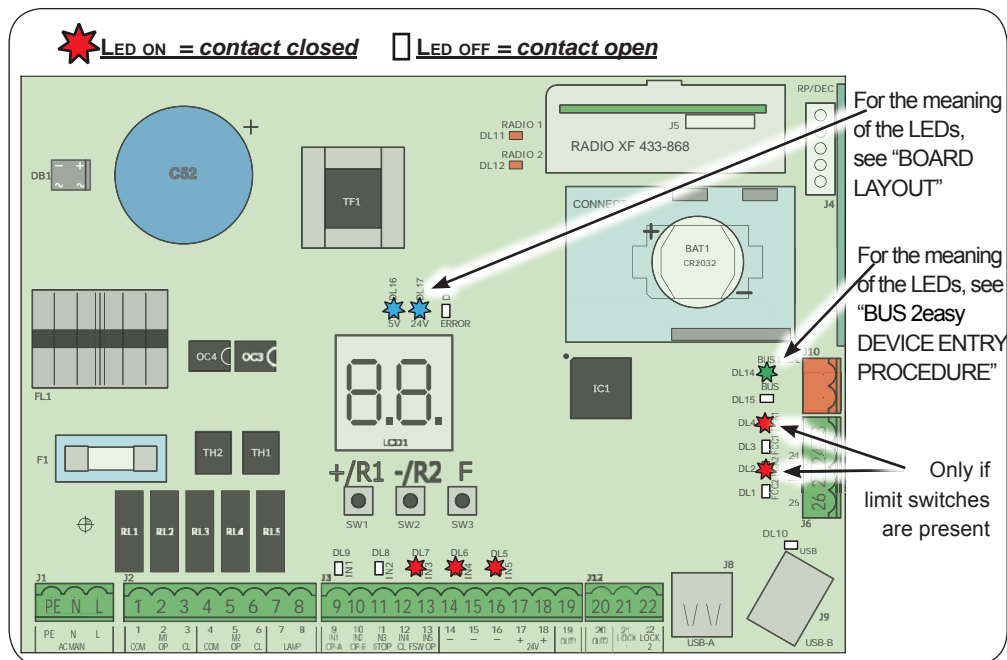

STOP - In default configuration, the STOP input is a safety input with contact N.C. (Normally Closed). The corresponding LED must be ON with the automated system at rest and go off when the connected device is activated.

OPEN A, OPEN B - In default configuration, the OPEN A, OPEN B inputs are inputs with contact N.O. (Normally Open). The corresponding LEDs must be OFF when the automated system is at rest, and go ON when the connected device is in use.

Led ERROR - FLASHING = there is an alarm in progress (situation that does not compromise gate operation) - see "ALARMS". **ON STEADY** = there is an error in progress (situation that blocks operation until the cause of the fault has been eliminated). See "ERRORS".

LEDs FCA1, FCC1, FCA2, FCC2 - show the status of the limit switches N.C. contacts.

LED	Name	ON (closed contact)	OFF (open contact)	with GATECODER
DL4	FCA1	OPEN limit switch clear	OPEN limit switch engaged	Flashing simultaneously during movement of leaf 1. When the leaf is stationary, they can both be either on or off
DL3	FCC1	CLOSE limit switch clear	CLOSE limit switch engaged	
DL2	FCA2	OPEN limit switch clear	OPEN limit switch engaged	Flashing simultaneously during movement of leaf 2. When the leaf is stationary, they can both be either on or off
DL1	FCC2	CLOSE limit switch clear	CLOSE limit switch engaged	

8. SIGNALLING ERRORS AND ALARMS

In case of **ERRORS** (conditions that stop gate operation) or **ALARMS** (conditions that do not compromise gate operation) the display will show the number corresponding to the warning in progress by simultaneously pressing **+** and **-**.

 *These warnings will disappear in the following cycle only if the situation causing them is removed.*

8.1 ERRORS

 *When there is an ERROR the ERROR LED will go on steady. By simultaneously pressing **+** and **-** the display will show the corresponding error number.*

The following table contains all the errors that can be viewed on the display.

N°	ERROR	SOLUTION
01	Board broken	Replace the board
05	Invalid SETUP	Repeat board SETUP
08	BUS 2easy device error	Ensure that no two pairs of devices have the same address.
09	BUS 2easy output short-circuit	Check the connections of the connected and entered BUS 2easy devices
10	Motor 2 limit switch error	Check the limit switch connections for motor 1
11	Motor 2 limit switch error	Check the limit switch connections for motor 1
12	BUS 2easy call	Ensure that the BUS devices are operating correctly and, if necessary, repeat BUS device acquisition
13	FAIL SAFE	Check that the safety devices (photocells) are operating correctly
14	Configuration error	Check that the board is configured correctly (basic and advanced programming) and, if necessary, repeat SETUP
17	Motor 1 encoder fault	Check the connections or replace motor 1 encoder
18	Motor 2 encoder fault	Check the connections or replace motor 2 encoder
19	Incorrect memory data	Repeat BUS 2easy device entry and/or re-program the board
93	High absorption at +24V	Check that absorption by the accessories connected is within permitted limits

8.2 ALARMS



When there is an ALARM the **ERROR LED** will begin to flash. By simultaneously pressing + and - the display will show the corresponding alarm number.

The following table contains all the alarms that can be viewed on the display.

N°	ALARM	Solution/Description
20	Obstacle on MOTOR 1 (only with encoder)	Remove any possible obstacle on leaf 1
21	Obstacle on MOTOR 2 (only with encoder)	Remove any possible obstacle on leaf 2
25	LOCK 1 output short-circuit	Remove the cause of the short-circuit
26	LOCK 2 output short-circuit	Remove the cause of the short-circuit
27	Nr. of consecutive obstacles exceeded during opening	Remove any possible obstacle. Should the problem persist, repeat SETUP
28	Nr. of consecutive obstacles exceeded during closing	Remove any possible obstacle. Should the problem persist, repeat SETUP
30	XF radio code memory full	Cancel the radio codes that are not being used using the PC program or use an additional DEC/MINIDEC/RP module
31	Breach alarm	A movement was made with the automated system in status St = 00 or 01 . Perform an operation cycle.
35	TIMER active and TIMER function operating:	TIMER function is operating
40	Service request	Contact the installer for maintenance
50	The HOLD POSITION is operating (active on PC/MAC)	HOLD POSITION function is operating
60	TIMER active and error in TIMER data	Reload a correct TIMER configuration with the PC/MAC programme
62	Loss of time and date on the board (only if the TIMER is operating)	Reload the time and date with the PC/MAC programme and replace the BAT1 - CR2032 buffer battery
63	JOLLY TIMER is activated	JOLLY TIMER is enabled by terminal board J3
64	TIMER DISABLED is operating	TIMER is disabled by terminal board J3

9. TROUBLESHOOTING

	Description	Solution
A	The board does not turn on	<ul style="list-style-type: none"> • Ensure that the board is receiving the 230V~ • Ensure that fuse F1 is intact
B	The gate will not open after an OPEN pulse	<ul style="list-style-type: none"> • Check that the safety devices and STOP are connected to the negative and ensure that the corresponding LEDs are ON • Check the photocells (alignment, engagement) • Check that the SETUP has been completed correctly. Repeat if necessary
C	The gate does not reverse when the photocells are engaged	<ul style="list-style-type: none"> • Check that the traditional photocells are correctly wired and that the BUS photocell configuration is correct (if present). If necessary, repeat the acquisition of the BUS 2easy devices
D	The gate does not reverse when encountering an obstacle	<ul style="list-style-type: none"> • Ensure that the encoders on motors are enabled • Check the obstacle detection sensitivity
E	The gate will not close	<ul style="list-style-type: none"> • Check that the photocell wiring and alignment is correct • Check that there is no OPEN signal active • Check which function logic has been chosen (automatic or semi-automatic)

10. MANAGING THE CONFIGURATION FILE – J8 USB

Using the J8 USB connector you can both transfer to the board the configuration and management files from a USB drive and copy the same files stored on the board to the USB memory. When transferring from the USB memory to the board, the files must be located in the memory root, as shown in the screenshot below:

In addition, the names and extensions of the various files must be as follows:

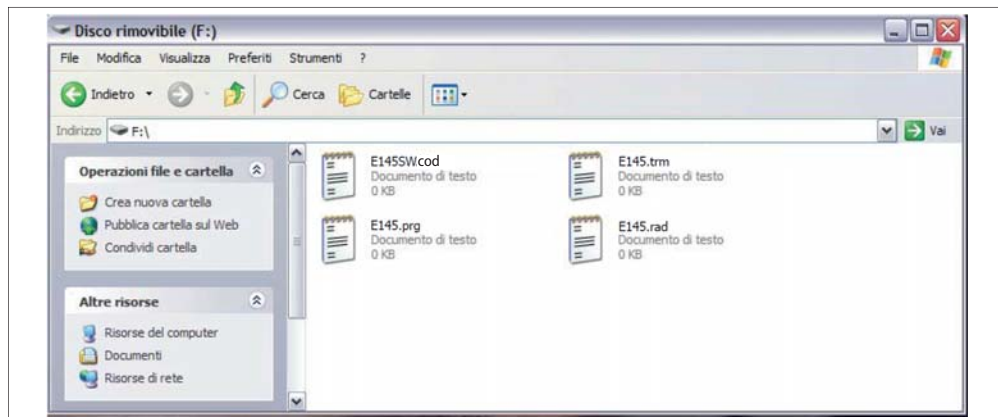

















- **E145SW.cod** - The board SOFTWARE update file
- **E145.trm** - The board TIMER update file
- **E145.prg** - The board PROGRAMMING update file
- **E145.rad** - The board RADIO update file









These files will be generated, named and placed as shown in fig. in case of transfer from the board to the USB memory.

If at board power up a USB memory is detected inserted in the board J8 connector, after displaying the writing **bo**, it will be possible to access the update file management menu (see the following table) (press **F** for scrolling through the functions) :

- ⓘ - The SOFTWARE update file must be downloaded from the FAAC website according to the version of the board. The filename must not be changed. For boards previous to version **1R**, the filename has a .bin extension; for version **1R** boards or later, the filename has a .cod extension.
- The file will transferred from the USB memory key to the board only if it has been saved in the root directory of the USB memory key and is not compressed.

Display	Function	Default
US	<p>BOARD SOFTWARE UPGRADE:</p> <p>This function lets you update the board application (file E145SW.cod). If + and - are pressed simultaneously for at least 5 seconds, you will access the board update. The writing no will disappear and, in its place, the writing -- and the USB DL10 LED will begin flashing.</p> <p>Once updating is completed, Y will be displayed if it has been done correctly, otherwise the writing no will appear again.</p> <p> The upgrade is carried out correctly only if the USB memory contains a valid file named exactly E145SW.cod</p>	--

Display	Function	Default
	<p>BOARD CONFIGURATION UPGRADE:</p> <p>This function lets you transfer the configuration to the board (file E145.prg). If + and - are pressed simultaneously for at least 5 seconds, you will access the board configuration update. The writing  will disappear and, in its place, the writing -- and the USB DL10 LED will begin flashing. Once updating is completed,  will be displayed if it has been done correctly, otherwise the writing  will appear again.</p> <p> The upgrade is carried out correctly only if the USB memory contains a valid file named exactly E145.prg</p>	<p>--</p>
	<p>TIMER CONFIGURATION UPGRADE:</p> <p>This function lets you update the timer configuration on the board (file E145.trm). If + and - are pressed simultaneously for at least 5 seconds, you will access the board update. The writing  will disappear and, in its place, the writing -- and the USB DL10 LED will begin flashing. Once updating is completed,  will be displayed if it has been done correctly, otherwise the writing  will appear again.</p> <p> The upgrade is carried out correctly only if the USB memory contains a valid file named exactly E145.trm</p>	<p>--</p>
	<p>RADIO CODE LIST UPGRADE:</p> <p>This function lets you update the radio code list on the board (file E145.rad). If + and - are pressed simultaneously for at least 5 seconds, you will access the board update. The writing  will disappear and, in its place, the writing -- and the USB DL10 LED will begin flashing. Once updating is completed  will be displayed if it has been done correctly, otherwise the writing  will appear again.</p> <p> The upgrade is carried out correctly only if the USB memory contains a valid file named exactly E145.rad</p>	<p>--</p>

Display	Function	Default
	<p>BOARD CONFIGURATION DOWNLOAD:</p> <p>This function lets you save the board configuration in the USB memory in order to store (parameter 01) or copy the configuration to other systems (parameter 00).</p> <p>If + and - are pressed simultaneously for at least 5 seconds, the following selection values will appear:</p> <p>01 = Storage: the configuration file will be saved in the format E145_xxx.prg where xxx=000/001/002 etc. depending on how many configuration files there are in the USB memory.</p> <p>00 = Copy: the configuration file will be saved in the format E145.prg by overwriting any other configuration file present with the same name, so it can be used to upgrade another system.</p> <p>Press + and - to select the desired parameter and, by pressing F, the board will proceed to save the file and display  when done correctly, or  in case of errors during saving.</p>	<p>--</p>
	<p>BOARD TIMER DOWNLOAD:</p> <p>This function lets you save the board Timer configuration in the USB memory in order to store (parameter 01) or copy the Timer configuration to other systems (parameter 00).</p> <p>If + and - are pressed simultaneously for at least 5 seconds, the following selection values will appear:</p> <p>01 = Storage: the Timer configuration file will be saved in the format E145_xxx.trm where xxx=000/001/002 etc. depending on how many Timer configuration files there are in the USB memory.</p> <p>00 = Copy: the Timer configuration file will be saved in the format E145.trm by overwriting any other Timer configuration file present with the same name, so it can be used to upgrade another system.</p> <p>Press + and - to select the desired parameter and, by pressing F, the board will proceed to save the file and display  when done correctly, or  in case of errors during saving.</p>	<p>--</p>
	<p>BOARD RADIO CODE DOWNLOAD:</p> <p>This function lets you save in the USB memory the board radio codes in order to store (parameter 01) or copy the radio codes to other systems (parameter 00).</p> <p>If + and - are pressed simultaneously for at least 5 seconds, the following selection values will appear:</p> <p>01 = Storage: the radio codes file will be saved in the format E145_xxx.rad where xxx=000/001/002 etc. depending on how many radio codes files there are in the USB memory.</p> <p>00 = Copy: the radio codes file will be saved in the format E145.rad by overwriting any other radio codes file present with the same name, so it can be used to upgrade another system.</p> <p>Press + and - to select the desired parameter and, by pressing F, the board will proceed to save the file and display  when done correctly, or  in case of errors during saving.</p>	<p>--</p>

11. FUNCTION LOGICS



This table summarizes the function logics.

For a detailed description of each one, see the queued Tables.

LOGIC		Automated system status: stopped	Automated system status: in motion	Status: photocell involvement
E	Semiautomatic	An OPEN pulse opens the gate and the following one will close it	An OPEN pulse while opening stops and reopens during closing	During motion, the photocells reverse
EP	Semiautomatic, Step-by-Step	An OPEN pulse opens the gate and the following one will close it	An OPEN pulse during motion blocks	During motion, the photocells reverse
S	Automatic Safety	An OPEN pulse opens the gate and closes automatically after the pause time	An OPEN pulse during pause closes and reverses during motion	The closing photocells reclose the gate during pause; they memorise closing during opening and immediately reverse during closing
SA	Automatic Safety reversing during pause	An OPEN pulse opens the gate and closes automatically after the pause time	An OPEN pulse during pause closes; during opening it has no effect; it reverses during closing	The closing photocells reset the pause time
SP	Automatic Safety Step-by-Step	An OPEN pulse opens the gate and closes automatically after the pause time	An OPEN pulse during pause closes and during motion blocks the operation	The closing photocells reclose the gate during pause; they memorise closing during opening and immediately reverse during closing
A1	Automatic 1	An OPEN pulse opens the gate and closes automatically after the pause time	An OPEN pulse during opening is ignored, during pause it recharges the pause time and during closing it reopens the leaves	The closing photocells reclose the gate during pause; they memorise closing during opening and immediately reverse during closing



A	Automatic	An OPEN pulse opens the gate and closes automatically after the pause time	An OPEN pulse during opening is ignored, during pause it recharges the pause time and during closing it reopens the leaves	The closing photocells recharge the pause time
AP	Automatic Step-by-Step	An OPEN pulse opens the gate and closes automatically after the pause time	An OPEN pulse during opening and during pause blocks the operation; it reverses during closing	The closing photocells recharge the pause time
At	Automatic Timer	An OPEN pulse opens the gate and closes automatically after the pause time. If the cycle started with an OPEN input, it opens, otherwise it closes	An OPEN pulse during opening is ignored, during pause it resets the pause time and during closing it reopens the leaves	The closing photocells recharge the pause time
b	Semiautomatic "b" (OPEN-B inputs become CLOSE)	Logic with two separate commands: OPEN-A pulse opens; CLOSE pulse closes	An OPEN-A pulse during closing opens, a CLOSE pulse during opening closes	During motion, the photocells reverse
bC	Mixed Logic (during opening "b", during closing "C"), (OPEN-B inputs become CLOSE)	Logic with two separate commands: OPEN-A pulse opens; a held CLOSE pulse closes	An OPEN-A pulse during closing opens, a CLOSE pulse during opening closes	During motion, the photocells reverse
C	Dead-man (OPEN-B inputs become CLOSE)	Logic with two separate commands: a held OPEN-A pulse opens; a held CLOSE pulse closes	An OPEN-A pulse during closing opens, a CLOSE pulse during opening closes	During motion, the photocells reverse



E SEMI-AUTOMATIC LOGIC

AUTOMATED SYSTEM STATUS	PULSES						
	OPEN A	OPEN B	CLOSE	STOP	FSW OP	FSW CL	FSW CL/OP
CLOSED	OPENS	OPENS PARTIALLY	NO EFFECT	NO EFFECT (OPEN DISABLED)		NO EFFECT	NO EFFECT (OPEN DISABLED)
OPENING	STOPS* 	STOPS*	CLOSES	STOPS*	REVERSES	NO EFFECT	STOPS; OPENS AT RELEASE (OPEN STOPS* - SAVES CLOSE)
OPEN	CLOSES 	CLOSES		NO EFFECT (OPEN/CLOSE DISABLED)	NO EFFECT	NO EFFECT (CLOSE DISABLED)	NO EFFECT (OPEN/CLOSE DISABLED)
CLOSING	OPENS		NO EFFECT	STOPS*	NO EFFECT	REVERSES 	STOPS; OPENS AT RELEASE (OPEN STOPS* - SAVES CLOSE)
STOPPED	CLOSES			NO EFFECT (OPEN/CLOSE DISABLED)	NO EFFECT (OPEN DISABLED)	NO EFFECT (CLOSE DISABLED)	NO EFFECT (OPEN STOPS - SAVES CLOSE)

ENGLISH

EP SEMI-AUTOMATIC “STEP-BY-STEP” LOGIC

AUTOMATED SYSTEM STATUS	PULSES						
	OPEN A	OPEN B	CLOSE	STOP	FSW OP	FSW CL	FSW CL/OP
CLOSED	OPENS	OPENS PARTIALLY	NO EFFECT	NO EFFECT (OPEN DISABLED)		NO EFFECT	NO EFFECT (OPEN DISABLED)
OPENING	STOPS* 	STOPS*	CLOSES	STOPS*	REVERSES	NO EFFECT	STOPS; OPENS AT RELEASE (OPEN STOPS* - SAVES CLOSE)
OPEN	CLOSES 	CLOSES		NO EFFECT (OPEN/CLOSE DISABLED)	NO EFFECT	NO EFFECT (CLOSE DISABLED)	NO EFFECT (OPEN/CLOSE DISABLED)
CLOSING	STOPS*		NO EFFECT	STOPS*	NO EFFECT	REVERSES 	STOPS; OPENS AT RELEASE (OPEN STOPS* - SAVES CLOSE)
STOPPED	RESTARTS MOVING IN THE OPPOSITE DIRECTION. ALWAYS CLOSES AFTER STOP		CLOSES	NO EFFECT (OPEN/CLOSE DISABLED)	NO EFFECT (OPEN DISABLED)	NO EFFECT (CLOSE DISABLED)	NO EFFECT (OPEN STOPS - SAVES CLOSE)

 *if the cycle began with OPEN-B, opens totally*
 *operation can be modified by programming*
 *it opens if, at power up, an OPEN (A or B) command is active. Otherwise it closes.*

S AUTOMATIC “SAFETY” LOGIC

ENGLISH

AUTOMATED SYSTEM STATUS	PULSES						
	OPEN A	OPEN B	CLOSE	STOP	FSW OP	FSW CL	FSW CL/OP
CLOSED	OPENS; CLOSES AFTER PAUSE TIME	OPENS PARTIALLY; CLOSES AFTER PAUSE TIME	NO EFFECT	NO EFFECT (OPEN DISABLED)		NO EFFECT	NO EFFECT (OPEN DISABLED)
OPENING	REVERSES		CLOSES	STOPS*	REVERSES	COMPLETES THE OPENING, THEN CLOSES WITHOUT PAUSE TIME	STOPS; OPENS AT RELEASE (SAVES CLOSE)
OPEN IN PAUSE	CLOSES ¹	CLOSES		STOPS*	NO EFFECT	STOPS; CLOSES AT RELEASE	
CLOSING	OPENS		NO EFFECT	STOPS*	NO EFFECT	REVERSES ² ; THEN CLOSES WITHOUT PAUSE TIME	STOPS; OPENS AT RELEASE, THEN CLOSES WITHOUT PAUSE TIME
*STOPPED	CLOSES			NO EFFECT (OPEN/CLOSE DISABLED)	NO EFFECT (OPEN DISABLED)	NO EFFECT (CLOSE DISABLED)	NO EFFECT (OPEN/CLOSE DISABLED)

SA AUTOMATIC “SAFETY” WITH IN-PAUSE REVERSING LOGIC

AUTOMATED SYSTEM STATUS	PULSES						
	OPEN A	OPEN B	CLOSE	STOP	FSW OP	FSW CL	FSW CL/OP
CLOSED	OPENS; CLOSES AFTER PAUSE TIME	OPENS PARTIALLY; CLOSES AFTER PAUSE TIME	NO EFFECT	NO EFFECT (OPEN DISABLED)		NO EFFECT	NO EFFECT (OPEN DISABLED)
OPENING	NO EFFECT ¹	NO EFFECT	CLOSES	STOPS*	REVERSES	NO EFFECT	STOPS; OPENS AT RELEASE (SAVES CLOSE)
OPEN IN PAUSE	CLOSES ¹	CLOSES		STOPS*	NO EFFECT	RECHARGES PAUSE TIME (CLOSE DISABLED)	
CLOSING	OPENS		NO EFFECT	STOPS*	NO EFFECT	REVERSES ²	STOPS; OPENS AT RELEASE (SAVES CLOSE)
*STOPPED	CLOSES			NO EFFECT (OPEN/CLOSE DISABLED)	NO EFFECT (OPEN DISABLED)	NO EFFECT (CLOSE DISABLED)	NO EFFECT (OPEN/CLOSE DISABLED)



¹ if the cycle began with OPEN-B, opens totally

² operation can be modified by programming

³ it opens if, at power up, an OPEN (A or B) command is active. Otherwise it closes.

SP AUTOMATIC “SAFETY” “STEP-BY-STEP” LOGIC





PULSES

AUTOMATED SYSTEM STATUS	OPEN A	OPEN B	CLOSE	STOP	FSW OP	FSW CL	FSW CL/OP
CLOSED	OPENS; CLOSES AFTER PAUSE TIME	OPENS PARTIALLY; CLOSES AFTER PAUSE TIME	NO EFFECT	NO EFFECT (OPEN DISABLED)		NO EFFECT	NO EFFECT (OPEN DISABLED)
OPENING	STOPS*  ¹	STOPS*	CLOSES	STOPS*	REVERSES	COMPLETES THE OPENING, THEN CLOSES WITHOUT PAUSE TIME	STOPS; OPENS AT RELEASE, THEN CLOSES WITHOUT PAUSE TIME (OPEN STOPS* - SAVES CLOSE)
OPEN IN PAUSE	CLOSES  ¹	CLOSES		STOPS*	NO EFFECT	STOPS; CLOSES AT RELEASE	
CLOSING	STOPS*		NO EFFECT	STOPS*	NO EFFECT	REVERSES  ²	STOPS; OPENS AT RELEASE (SAVES CLOSE)
*STOPPED	RESTARTS MOVING IN THE OPPOSITE DIRECTION. ALWAYS CLOSES AFTER STOP		CLOSES	NO EFFECT (OPEN/CLOSE DISABLED)	NO EFFECT (OPEN DISABLED)	NO EFFECT (CLOSE DISABLED)	NO EFFECT (OPEN/ CLOSE DISABLED)

ENGLISH

AI AUTOMATIC 1 LOGIC

PULSES

AUTOMATED SYSTEM STATUS	OPEN A	OPEN B	CLOSE	STOP	FSW OP	FSW CL	FSW CL/OP
CLOSED	OPENS; CLOSES AFTER PAUSE TIME	OPENS PARTIALLY; CLOSES AFTER PAUSE TIME	NO EFFECT	NO EFFECT (OPEN DISABLED)		NO EFFECT	NO EFFECT (OPEN DISABLED)
OPENING	NO EFFECT  ¹	NO EFFECT	CLOSES	STOPS*	 ²	COMPLETES THE OPENING, THEN CLOSES WITHOUT PAUSE TIME	STOPS; OPENS AT RELEASE, THEN CLOSES WITHOUT PAUSE TIME
OPEN IN PAUSE	RECHARGES PAUSE TIME  ¹	RECHARGES PAUSE TIME	CLOSES	STOPS*	NO EFFECT	DISABLES CLOSE; AT RELEASE CLOSES	AT THE END OF THE PAUSE TIME, CLOSES AT RELEASE
CLOSING	OPENS		NO EFFECT	STOPS*	NO EFFECT	REVERSES  ²	STOPS; OPENS AT RELEASE, THEN CLOSES AFTER PAUSE TIME
*STOPPED	CLOSES			NO EFFECT (OPEN/CLOSE DISABLED)	NO EFFECT (OPEN DISABLED)	NO EFFECT (CLOSE DISABLED)	NO EFFECT (OPEN/CLOSE DISABLED)



¹ if the cycle began with OPEN-B, opens totally

² operation can be modified by programming

³ it opens if, at power up, an OPEN (A or B) command is active. Otherwise it closes.

A AUTOMATIC LOGIC



PULSES

AUTOMATED SYSTEM STATUS	OPEN A	OPEN B	CLOSE	STOP	FSW OP	FSW CL	FSW CL/OP
CLOSED	OPENS; CLOSES AFTER PAUSE TIME	OPENS PARTIALLY; CLOSES AFTER PAUSE TIME	NO EFFECT	NO EFFECT (OPEN DISABLED)		NO EFFECT	NO EFFECT (OPEN DISABLED)
OPENING	NO EFFECT  ¹	NO EFFECT	CLOSES	STOPS*	REVERSES	NO EFFECT	STOPS; OPENS AT RELEASE (SAVES CLOSE)
OPEN IN PAUSE	RECHARGES PAUSE TIME  ¹	RECHARGES PAUSE TIME	CLOSES	STOPS*	NO EFFECT	RECHARGES PAUSE TIME (CLOSE DISABLED)	
CLOSING	OPENS		NO EFFECT	STOPS*	NO EFFECT	REVERSES  ²	STOPS; OPENS AT RELEASE (SAVES CLOSE)
*STOPPED	CLOSES			NO EFFECT (OPEN/CLOSE DISABLED)	NO EFFECT (OPEN DISABLED)	NO EFFECT (CLOSE DISABLED)	NO EFFECT (OPEN/ CLOSE DISABLED)

ENGLISH

AP AUTOMATIC "STEP-BY-STEP" LOGIC

PULSES

AUTOMATED SYSTEM STATUS	OPEN A	OPEN B	CLOSE	STOP	FSW OP	FSW CL	FSW CL/OP
CLOSED	OPENS; CLOSES AFTER PAUSE TIME	OPENS PARTIALLY; CLOSES AFTER PAUSE TIME	NO EFFECT	NO EFFECT (OPEN DISABLED)		NO EFFECT	NO EFFECT (OPEN DISABLED)
OPENING	STOPS*  ¹	STOPS*	CLOSES	STOPS*	REVERSES (SAVES OPEN)	NO EFFECT	STOPS; OPENS AT RELEASE (OPEN STOPS* - SAVES CLOSE)
OPEN IN PAUSE	STOPS* ¹	STOPS*	CLOSES	STOPS*	NO EFFECT	RECHARGES PAUSE TIME (CLOSE DISABLED)	
CLOSING	OPENS		NO EFFECT	STOPS*	NO EFFECT	REVERSES  ²	STOPS; OPENS AT RELEASE (OPEN STOPS* - SAVES CLOSE)
*STOPPED	CLOSES			NO EFFECT (OPEN/CLOSE DISABLED)	NO EFFECT (OPEN DISABLED)	NO EFFECT (CLOSE DISABLED)	NO EFFECT (OPEN/ CLOSE DISABLED)

¹ if the cycle began with OPEN-B, opens totally

² operation can be modified by programming

³ it opens if, at power up, an OPEN (A or B) command is active. Otherwise it closes.

AT AUTOMATIC WITH TIMER FUNCTION LOGIC ^{1,3}

PULSES

AUTOMATED SYSTEM STATUS	OPEN A	OPEN B	CLOSE	STOP	FSW OP	FSW CL	FSW CL/OP
CLOSED	OPENS; CLOSES AFTER PAUSE TIME	OPENS PARTIALLY; CLOSES AFTER PAUSE TIME	NO EFFECT	NO EFFECT (OPEN DISABLED)		NO EFFECT	NO EFFECT (OPEN DISABLED)
OPENING	NO EFFECT ¹	NO EFFECT	CLOSES	STOPS*	REVERSES	NO EFFECT	STOPS; OPENS AT RELEASE (SAVES CLOSE)
OPEN IN PAUSE	RECHARGES PAUSE TIME ¹	RECHARGES PAUSE TIME	CLOSES	STOPS*	NO EFFECT	RECHARGES PAUSE TIME (CLOSE DISABLED)	
CLOSING	OPENS		NO EFFECT	STOPS*	NO EFFECT	REVERSES ²	STOPS; OPENS AT RELEASE (SAVES CLOSE)
*STOPPED	CLOSES			NO EFFECT (OPEN/CLOSE DISABLED)	NO EFFECT (OPEN DISABLED)	NO EFFECT (CLOSE DISABLED)	NO EFFECT (OPEN/ CLOSE DISABLED)

ENGLISH

b SEMI-AUTOMATIC “B” LOGIC (OPEN-B INPUTS BECOME CLOSE)

PULSES

AUTOMATED SYSTEM STATUS	OPEN A	OPEN B	CLOSE	STOP	FSW OP	FSW CL	FSW CL/OP
CLOSED	OPENS	NO EFFECT	NO EFFECT (OPEN DISABLED)		NO EFFECT	NO EFFECT (OPEN DISABLED)	
OPENING	NO EFFECT	CLOSES	STOPS*	REVERSES	NO EFFECT	STOPS; CLOSES AT RELEASE (SAVES OPEN/CLOSE)	
OPEN	NO EFFECT	CLOSES	NO EFFECT (OPEN/CLOSE DISABLED)	NO EFFECT	NO EFFECT (CLOSE DISABLED)	NO EFFECT (OPEN/ CLOSE DISABLED)	
CLOSING	OPENS	NO EFFECT	STOPS*	NO EFFECT	REVERSES ²	STOPS; OPENS AT RELEASE (SAVES OPEN/CLOSE)	
*STOPPED	OPENS	CLOSES	NO EFFECT (OPEN/CLOSE DISABLED)	NO EFFECT (OPEN DISABLED)	NO EFFECT (CLOSE DISABLED)	NO EFFECT (OPEN/ CLOSE DISABLED)	

¹ if the cycle began with OPEN-B, opens totally

² operation can be modified by programming

³ it opens if, at power up, an OPEN (A or B) command is active. Otherwise it closes.

bc MIXED LOGIC: B IN OPENING - C IN CLOSING (OPEN-B INPUTS BECOME CLOSE)

ENGLISH

AUTOMATED SYSTEM STATUS	PULSES FOR OPENING / DEAD-MAN COMMANDS FOR CLOSING			PULSES			
	OPEN A	OPEN B	CLOSE	STOP	FSW OP	FSW CL	FSW CL/OP
CLOSED	OPENS	NO EFFECT		NO EFFECT (OPEN DISABLED)		NO EFFECT	NO EFFECT (OPEN DISABLED)
OPENING	NO EFFECT	CLOSES		STOPS*	REVERSES	NO EFFECT	STOPS; CLOSES AT RELEASE (SAVES OPEN/CLOSE)
OPEN	NO EFFECT	CLOSES		NO EFFECT (OPEN/CLOSE DISABLED)	NO EFFECT	NO EFFECT (CLOSE DISABLED)	NO EFFECT (OPEN/CLOSE DISABLED)
CLOSING	OPENS	NO EFFECT		STOPS*	NO EFFECT	REVERSES ¹ ₂	STOPS; OPENS AT RELEASE (SAVES OPEN/CLOSE)
*STOPPED	OPENS	CLOSES		NO EFFECT (OPEN/CLOSE DISABLED)	NO EFFECT (OPEN DISABLED)	NO EFFECT (CLOSE DISABLED)	NO EFFECT (OPEN/CLOSE DISABLED)

C DEAD-MAN LOGIC (OPEN-B INPUTS BECOME CLOSE)

AUTOMATED SYSTEM STATUS	DEAD-MAN COMMANDS			PULSES			
	OPEN A	OPEN B	CLOSE	STOP	FSW OP	FSW CL	FSW CL/OP
CLOSED	OPENS	NO EFFECT		NO EFFECT (OPEN DISABLED)		NO EFFECT	NO EFFECT (OPEN DISABLED)
OPENING	NO EFFECT	CLOSES		STOPS*	REVERSES	NO EFFECT	STOPS; CLOSES AT RELEASE (SAVES OPEN/CLOSE)
OPEN	NO EFFECT	CLOSES		NO EFFECT (OPEN/CLOSE DISABLED)	NO EFFECT	NO EFFECT (CLOSE DISABLED)	NO EFFECT (OPEN/CLOSE DISABLED)
CLOSING	OPENS	NO EFFECT		STOPS*	NO EFFECT	REVERSES ¹ ₂	STOPS; OPENS AT RELEASE (SAVES OPEN/CLOSE)
*STOPPED	OPENS	CLOSES		NO EFFECT (OPEN/CLOSE DISABLED)	NO EFFECT (OPEN DISABLED)	NO EFFECT (CLOSE DISABLED)	NO EFFECT (OPEN/CLOSE DISABLED)

¹ if the cycle began with OPEN-B, opens totally
² operation can be modified by programming

³ it opens if, at power up, an OPEN (A or B) command is active. Otherwise it closes.

FAAC

FAAC S.p.A. Soc. Unipersonale
Via Calari, 10 - 40069 Zola Predosa BOLOGNA - ITALY
Tel. +39 051 61724 - Fax +39 051 758518
www.faac.it - www.faacgroup.com

732784 - Rev. B